

MPC-SVPWM based Controller for PMSM Drives

Thangarajan. K*, Soundarrajan. A**

*RVS College of Engineering and Technology, Coimbatore, India. Email:thangarajansk@gmail.com

** PSG College of Technology, Coimbatore, India

Abstract- In this paper, a model predictive control based drive for the permanent magnet synchronous motor is proposed. This proposed method is suggested to achieve high dynamic torque in the PMSM. The control variable's long run behavior is predicted by the MPC within the time domain of the control system and the selection of the optimization cost function. This method combines the advantages of the MPC and SVPWM technique for PMSM drive to overcome the variations in the electromagnetic variables and also supplies fixed frequency for the inverter. The effectiveness of the proposed method is analysed and demonstrated in the simulations. The experimental set up is done with a frequency inverter that controls the PMSM motor. The dead time for the inverter is fixed to prevent a shoot-through fault. The experimental results are presented which shows the PMSM performance.

Keywords- Model Predictive Controller (MPC), Space Vector Pulse Width Modulation SVPWM, Permanent Magnet Synchronous Motor (PMSM).

I. INTRODUCTION

PMSM found wide application where variable torque and speed control is required. PMSM has high dynamic performance, torque to weight ratio and high power density which needs precise dynamic control methods. In general Direct Torque Control (DTC) and Field Oriented Control (FOC) are the two famous speed control methods for the PMSM drives.

The principle of DTC control is based on the values of flux, torque and rotor position estimation. This method does not need any sensors to measure the mechanical position of rotors. DTC has the advantages over the other methods are no need of current controllers position sensors and transformation networks. It has the drawbacks of high current ripples, torque ripples variable switching frequency and speed control in low speed is difficult [6-7][10].

FOC Technique is to control torque and flux by controlling its corresponding current components which are derived from stationary reference frame to rotating reference frame. The advantages of FOC is independent flux and torque control can be achieved. It has fast dynamic torque comparatively with DTC and better steady and transient state response [12]. High torque and low current during starting of the motor can be achieved in this method.

MPC is more suitable in parameter sensitivity evaluation than other methods. MPC combines the advantage of DTC and classical FOC. The cost function design strategy in MPC will be chosen based on the power rating. In high power rating, the switching losses is to be reduced by reducing the switching frequency and in low power application is to achieve high dynamics [8-9]. MPC control for PMSM are presented in [1-5]. The main focus of this paper is designing and implementing a high performance MPC-SVPWM control for PMSM and the results are compared with classical FOC.

II. MODELLING OF PMSM

The model of PMSM drive covers the current and voltage relations at equilibrium and individual phase voltage distribution [11]. The model has no. of parameters and thus notations are as follows.

v_d	- d -axis stator voltages
v_q	- q -axis stator voltages
i_d	- d -axis stator currents
i_q	- q -axis stator currents
ϕ_d	- d -axis flux linkages
ϕ_q	- q -axis flux linkages
r_s	- Stator resistance
θ	- Rotor angle
L_d	- d -axis synchronous inductances
L_q	- q -axis synchronous inductances
ϕ_f	- Permanent magnetic flux
ω_e	- rotor speed
T_e	- Electromagnetic torque
T_l	- Load torque
ω_r	- Mechanical speed of rotor
J	- Moment of inertia
B	- Shaft friction coefficient
T_e^*	- Reference torque
ϕ_s^*	- Reference flux
T_e^{k+1}	- Predicted torque
ϕ_s^{k+1}	- Predicted flux
k_1	- Weighting factor
v_d^k, v_q^k	- Stator voltages at instant k

- i_d^k, i_q^k - Stator currents at instant k
 ω_e^k - Rotor speed at instant k
 T_s - Sampling time
 T_e^{k+2} - Electromagnetic torque at instant $k+2$
 ϕ_s^{k+2} - Stator flux at instant $k+2$
 V_d, V_q, V_0 - Voltage vectors
 T_4, T_6, T_0 - Time periods
 V_{dc} - reference DC voltage
 $V_{s\alpha ref}, V_{s\beta ref}$ - components of reference voltage

The PMSM is described by the rotating d-q reference frame axis voltage equations

$$v_d = r_s i_d + \frac{d\phi_d}{dt} + \phi_q \frac{d\theta}{dt} \quad (1)$$

$$v_q = r_s i_q + \frac{d\phi_q}{dt} + \phi_d \frac{d\theta}{dt} \quad (2)$$

The d-axis and q-axis fluxes are linkages are given by

$$\phi_d = L_d i_d + \phi_f \quad (3)$$

$$\phi_q = L_q i_q \quad (4)$$

The equations (1) and (2) can be written as

$$v_d = r_s i_d + L_d \frac{di_d}{dt} - \omega_e L_q i_q \quad (5)$$

$$v_q = r_s i_q + L_q \frac{di_q}{dt} + \omega_e L_d i_d + \omega_e \phi_f \quad (6)$$

The mechanical torque of the model can be

$$T_e = T_l + J \frac{d\omega_r}{dt} + B\omega_r \quad (7)$$

The electromagnetic torque is derived as

$$T_e = \frac{3}{4} p(\phi_d i_q - \phi_q i_d) \quad (8)$$

Substituting (3) and (4) to (8), T_e can be rewritten as

$$T_e = \frac{3}{4} p(\phi_f i_q + (L_d - L_q) i_d i_q) \quad (9)$$

The electromagnetic torque is the combination of permanent magnet torque and reluctance torque. The synchronous inductance of the PMSM equals the d and q axis inductance. Neglecting the reluctance torque, electromagnetic torque can be rewritten as

$$T_e = \frac{3}{4} p(\phi_f i_q) \quad (10)$$

III. MPC-SVPWM CONTROL OF PMSM

The proposed MPC-SVPWM method fed PMSM drive shown in Fig. 1. The comparison is made between reference and actual speed. The error

in speed is given to PI controller and the torque reference is given to MPC. According to the MTPA principle stator flux reference is calculated and fed to MPC controller. The voltage vector selected by SVPWM reduces the difference between the predicted and reference values.

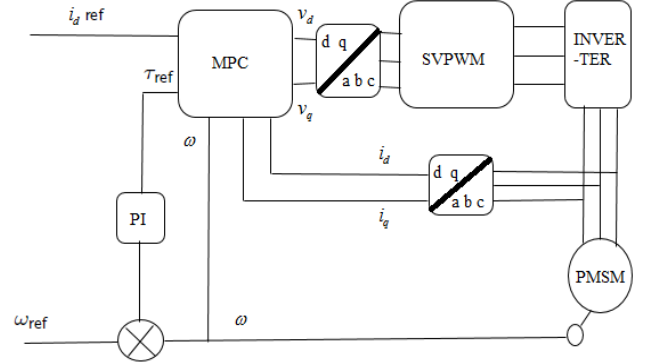

Fig. 1. Proposed MPC-SVPWM fed PMSM drive

The factors considered as cost function of MPC are torque and the stator flux [12-14]. These cost functions should be made to approach reference values at the end of the control period. The cost function G is given by

$$\min.G = |T_e^* - T_e^{k+1}| + k_1 |\phi_s^* - \phi_s^{k+1}| \quad (11)$$

The stator currents in the reference frame are given by

$$\frac{di_d}{dt} = \frac{-r_s i_d + \omega_e L_q i_q + v_d}{L_d} \quad (12)$$

$$\frac{di_q}{dt} = \frac{-r_s i_q - \omega_e L_d i_d + v_q - \omega_e \phi_f}{L_q} \quad (13)$$

At instance $k+1$ the currents are derived as

$$i_d^{k+1} = i_d^k + \left(\frac{-r_s i_d^k + \omega_e^k L_q i_q^k + v_d^k}{L_d} \right) T_s \quad (14)$$

$$i_q^{k+1} = i_q^k + \left(\frac{-r_s i_q^k - \omega_e^k L_d i_d^k + v_q^k - \omega_e^k \phi_f}{L_q} \right) T_s \quad (15)$$

At instance $k+1$ the electromagnetic torque flux linkages are derived as

$$\phi_d^{k+1} = L_d i_d^{k+1} + \phi_f \quad (16)$$

$$\phi_q^{k+1} = L_q i_q^{k+1} \quad (17)$$

$$T_e^{k+1} = \frac{3}{4} p(\phi_d^{k+1} i_q^{k+1} + \phi_q^{k+1} i_d^{k+1}) \quad (18)$$

To eliminate the digital implementation step delay, the cost function can be changed

$$\min.G = |T_e^* - T_e^{k+2}| + k_1 |\phi_s^* - \phi_s^{k+2}| \quad (19)$$

A two-step prediction is required to obtain this minimum cost function.

IV. VOLTAGE SPACE VECTOR MODULATION

The phase voltages for the PMSM are generated using SVPWM and are applied to the stator phases. The space sector plane is divided by six sectors. From these sectors the voltage vectors are generated as shown in Fig.2.

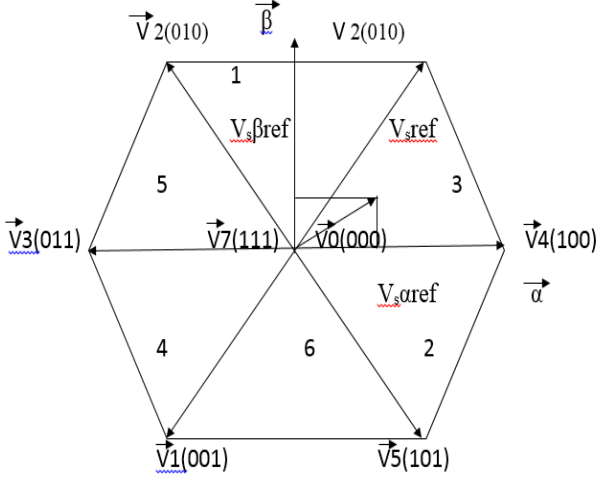

Fig. 2. Voltage vectors

Consider the reference voltage vector V_{sref} in the 3rd sector of the space vector plane. All the sectors are given the application time which is derived as in equation (20). The reference voltage vector V_{sref} can be given as in (21).

$$T = T_4 + T_6 + T_0 \quad (20)$$

$$V_{sref} = \frac{T_4}{T} V_4 + \frac{T_6}{T} V_6 + V_0 \quad (21)$$

The application time of the adjacent vector is given as

$$T_4 = \frac{T_4}{2V_{dc}} (3V_{sref} - \sqrt{3}V_{s\beta ref}) \quad (22)$$

$$T_6 = \sqrt{3} \frac{T}{V_{dc}} V_{s\beta ref} \quad (23)$$

The variable associated with vector application time is expressed as

$$X = \sqrt{3} \frac{T}{V_{dc}} V_{s\beta ref} \quad (24)$$

$$Y = \sqrt{3} \frac{T}{2V_{dc}} V_{s\beta ref} + 3 \frac{T}{2V_{dc}} V_{sref} \quad (25)$$

$$Z = \sqrt{3} \frac{T}{2V_{dc}} V_{s\beta ref} - 3 \frac{T}{2V_{dc}} V_{sref} \quad (26)$$

With the knowledge of each sector the voltage vectors are defined by V_{sref} and $V_{s\beta ref}$. The boundary vector durations are tabulated in the Table .1.

Table .1 Application durations of the sector boundary vectors

Sector	i	ii	iii	iv	v	vi
t ₁	z	y	-z	-x	x	-y
t ₂	y	-x	x	z	-y	-z

The calculated duty cycles are

$$t_{A_ON} = \frac{T - T_4 - T_6}{2} \quad (27)$$

$$t_{B_ON} = t_{A_ON} + T_4 \quad (28)$$

$$t_{C_ON} = t_{B_ON} + T_6 \quad (29)$$

Table .2 represents the duty cycle according to the sector for the motor phases.

Table.2 Duty cycle to the motor phases

Sector / Phase	i	ii	iii	iv	v	vi
S _A	t _{B_ON}	t _{A_ON}	t _{A_ON}	t _{C_ON}	t _{B_ON}	t _{C_ON}
S _B	t _{A_ON}	t _{C_ON}	t _{B_ON}	t _{B_ON}	t _{C_ON}	t _{A_ON}
S _C	t _{C_ON}	t _{B_ON}	t _{C_ON}	t _{A_ON}	t _{A_ON}	t _{B_ON}

V. SIMULATION OF THE PROPOSED SYSTEM

The proposed method of MPC-SVPWM for the PMSM is modelled using MATLAB / Simulink. The simulation is done with 20 kHz of sampling frequency. A VSI with IGBT switches is fed from a 380V, 50Hz supply in modelled. The PMSM model using d-q reference frame is fed from the inverter. The Table .3 shows the motor parameters used in the simulation. The DC link capacitance across the inverter is fixed as 1F and the speed is set to 3600 rpm. The difference between actual and reference speed is given the PI controller which generates the reference torque T_e and stator reference flux ϕ_s . The three phase voltage V_a , V_b , and V_c are obtained using park transformation a constant value of torque is given. The two phase current i_d and i_q are obtained from rotor speed, electromagnetic torque T_e , and the rotor position using equation (5), (6),(7) and (9). By using inverse park transformation the two phone current are converted as three phase currents i_a , i_b and i_c .

From the equation (14) and (15) the current prediction values are derived. Similarly for the voltages the current values i_d , i_q are replaced by i_d^{k+1} , i_q^{k+1} . The second step prediction is also done by replacing i_d^k, i_q^k at instant $k+2$ by i_d^{k+1} , i_q^{k+1} in the equation (14) and (15).

The torque and flux prediction can also done by equation (16) (17) and (18).

The cost function optimization has been obtained from (19). The equation (24), (25) and (26) gives the commutation durations of the switches. The boundary vectors duration is calculated as per the Table .2 and also the switching sequences are computed using (27), (28) and (29).

The Fig.3, Fig.4, Fig.5 and Fig.6 shows stator currents, switching pulses, speed and torque wave forms.

For surface PMSM, the relationship between T_e^* and φ_s^* is

$$|\varphi_s^*| = \sqrt{\varphi_f^2 + \left(\frac{L_q T_e^*}{\frac{3}{2} p \varphi_f}\right)^2} \quad (30)$$

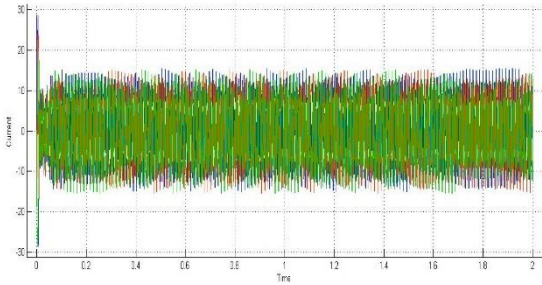

Fig. 3. Simulation response of Phase currents the PMSM drive with MPC-SVPWM

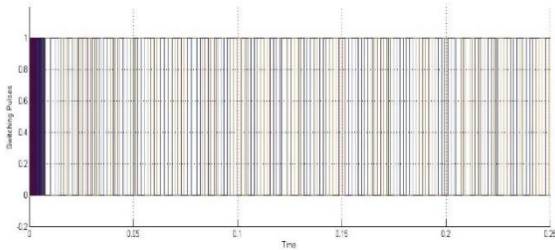

Fig. 4. Switching Pulses to the Inverter

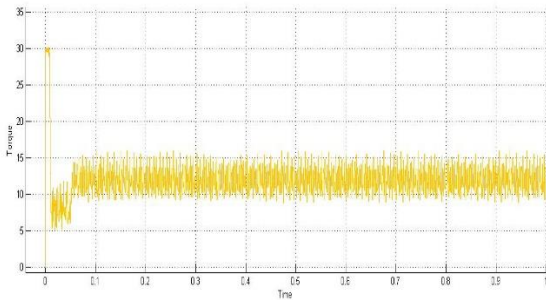

Fig. 5. Simulative response of Torque

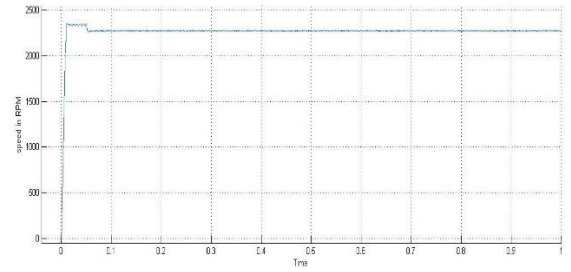

Fig. 6. Simulation response of Speed of the PMSM with MPC-SVPWM

VI. EXPERIMENTAL RESULTS

The experimental setup for the proposed method is shown in Fig .13. The steady state and transient state performance is investigated and compared with classical FOC. To implement the control algorithm ARM cortex M3 micro controller which operates at a CPU frequency of 100MHz. The advantages of this microcontroller are computation speed, separate local instruction and peripheral bus. For the speed measurement an incremental optical encoder is used and 100 micro second sample time is set for all the experiments. The experimental results are plotted as shown in Fig .7, Fig.8, and Fig.9.

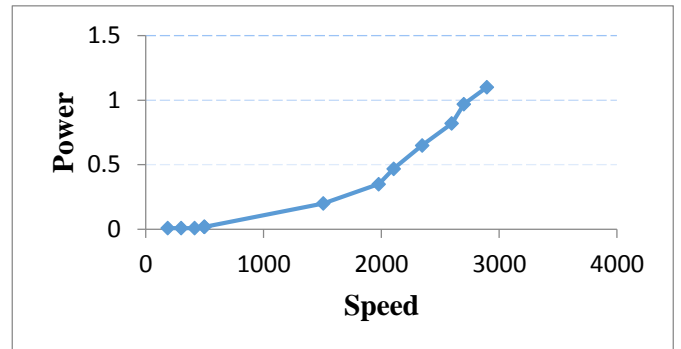

Fig.7 Experimental result of output power of the MPC-SVPWM

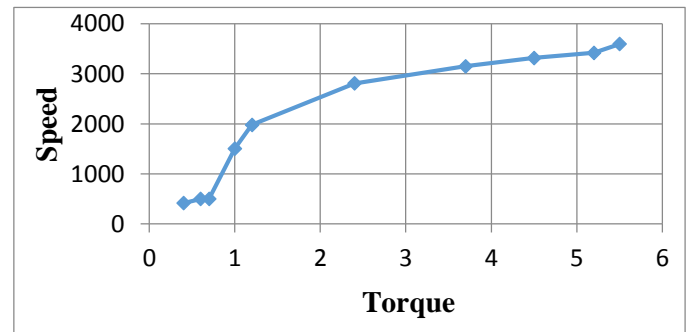

Fig.8. Torque speed relationship of the MPC-SVPWM method

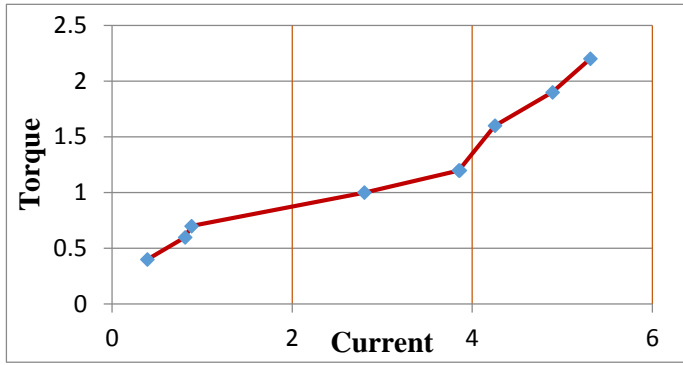

Fig.9. Torque Response of the MPC-SVPWM method

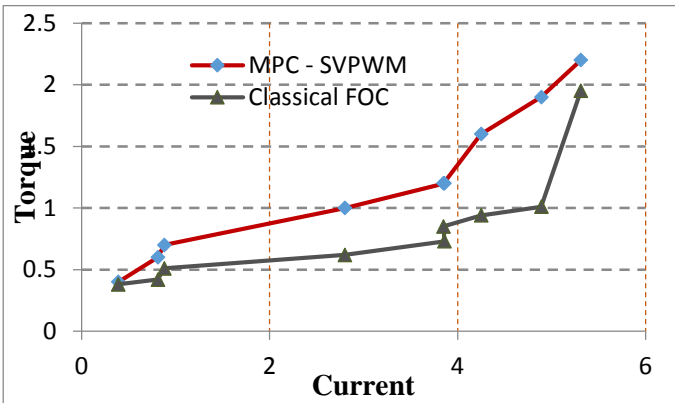

Fig.10. Performance comparison of output torque

It can be said that the predictive controller implementation is relatively easy compared with the classic FOC scheme as shown in Fig.10, Fig.11 and Fig.12. The predictive controller is based on the model of the motor drive in order to predict the future value. Therefore, the main difficulty comes in the precision of the model parameters. According to the experimental results, although in steady state FOC is still better, MPC has an acceptable steady state performance with a low current ripple and an improved transient response. MPC-SVPWM is proved as a good alternative to FOC with an improved torque and dynamic performance.

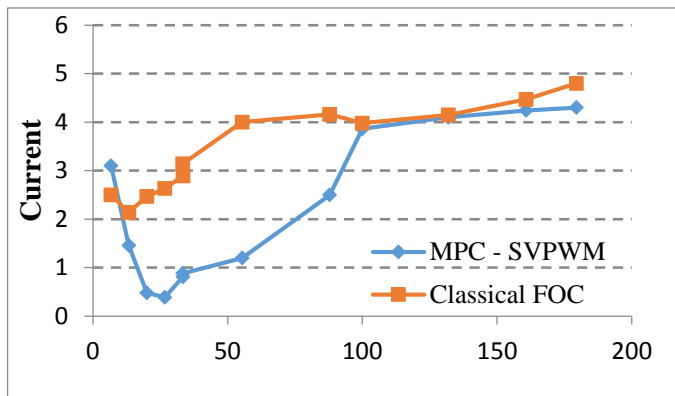

Fig. 11. Comparison of input currents

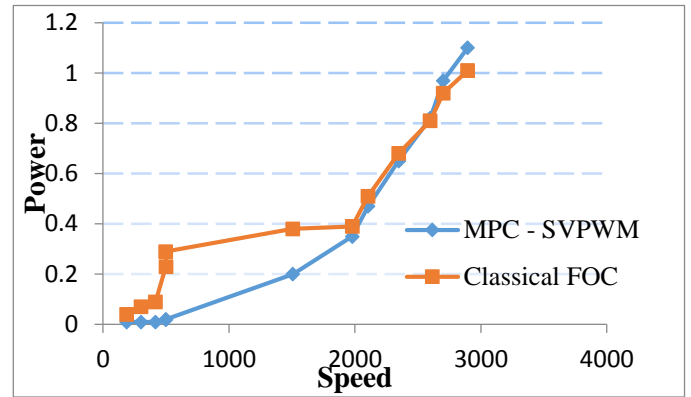

Fig.12. Performance comparison of output power

Table .3. Motor Parameters

Parameter	Value
KW	2.2 kw
Rated torque	5.8 N-m
Rated Current	4.5 Amps
speed	3600 rpm
B_{EMF}	283 V
Frequency	180 Hz
Stator inductance	13.3 mH
Stator Resistance	2.8 ohm

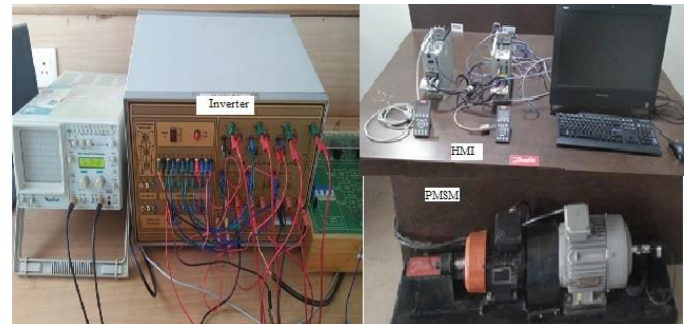

Fig.13. Experimental Setup

VII. CONCLUSION

MPC SVPWM is chosen in this paper among many control schemes are available in PMSM drives, because of its simplicity in the implementation and flexibility. The MPC-SVPWM and classical FOC methods are considered for the comparison. Both the controller were modelled in MATLAB / Simulink and the results are compared. The designs are also implemented in laboratory. Based on the experimental results the MPC – SVPWM method found as the better replacement for the classical FOC.

REFERENCES

- [1] Turker Turker and A. Faruk Bakan, "A Robust Predictive Current Controller for PMSM Drives" *IEEE Transactions on Industrial Electronics*, Vol. 63, NO. 6, June 2016.
- [2] B. S. Riar, T. Geyer, and U. K. Madawala, "Model predictive direct current control of modular multilevel converters: Modeling, analysis, and Experimental evaluation," *IEEE Trans. Power Electron.*, vol. 30, pp. 431–439, Jan. 2015.
- [3] J. Scoltock, T. Geyer, and U. Madawala, "Model predictive direct power control for grid-connected NPC converters," *IEEE Trans. Ind. Electron.*, vol. 62, no. 9, pp. 5319–5328, Sep. 2015.
- [4] C.-S. Lim, E. Levi, M. Jones, N. A. Rahim, and W.-P. Hew, "A comparative study of synchronous current control schemes based on FCS-MPC and PI-PWM for a two-motor three-phase drive," *IEEE Trans. Ind. Electron.*, vol. 61, no. 8, pp. 3867–3878, Aug. 2014.
- [5] Zhixun Ma, Saeid Saeidi and Ralph Kennel, "FPGA implementation of Model Predictive Control with constants switching frequency for PMSM drives", *IEEE transactions on industrial informatics*, Volume. 10, No. 5, November 2014.
- [6] Mohammad Hossein Vafaie, Behzad Mirzaeian Dehkordi, Payman Moallem, and Arash Kiyoumars, "A New Predictive Direct Torque Control Method for Improving Both Steady-State and Transient-State Operations of the PMSM" *IEEE Transactions on Power Electronics*, Vol. 31, No. 5, May 2016.
- [7] C. Xia, J. Zhao, Y. Yan, and T. Shi, "A novel direct torque and flux control method of matrix converter-fed PMSM drives," *IEEE Trans. Power Electron.*, vol. 29, no. 10, pp. 5417–5430, Oct. 2014.
- [8] J. Rodriguez *et al.*, "State of the art of finite control set model predictive control in power electronics," *IEEE Trans. Ind. Informat.*, vol. 9, no. 2, pp. 1003–1016, May 2013.
- [9] Zbynek Mynar, Libor Vesely, and Pavel Vaclavek, "PMSM Model Predictive Control with Field-Weakening Implementation" *IEEE Transactions on Industrial Electronics*, Vol. 63, No. 8, August 2016.
- [10] Andres Mora, Alvaro Orellana, Jorge Juliet, and Roberto Cardenas, "Model Predictive Torque Control for Torque Ripple Compensation in Variable-Speed PMSMs" *IEEE Transactions on Industrial Electronics*, Vol. 63, No. 7, July 2016.
- [11] A. Gebregergis, M. Chowdhury, M. Islam, and T. Sebastian, "Modeling of permanent-magnet synchronous machine including torque ripple effects," *IEEE Trans. Ind. Electron.*, vol. 51, no. 1, pp. 232–239, Jan. 2015.
- [12] Yan Yan, Shuai Wang, Changliang Xia, , Huimin Wang and Tingna Shi , "Hybrid Control Set-Model Predictive Control for Field-Oriented Control of VSI-PMSM", *IEEE Transactions on Energy Conversion*, Vol. 31, No. 4, December 2016.
- [13] Tomasz Tarczewski and Lech M. Grzesiak, "Constrained State Feedback Speed Control of PMSM Based on Model Predictive Approach", *IEEE Transactions on Industrial Electronics*, Vol. 63, No. 6, June 2016.
- [14] M. Preindl and S. Bolognani, "Model predictive direct speed control with finite control set of PMSM drive systems," *IEEE Trans. Power Electron.*, vol. 28, no. 2, pp. 1007–1015, Feb. 2013.