

Modeling and Vector Control of two five-phase synchronous magnet permanent machines (PMSM) connected in series

M. NEKKAZ Mohamed

University Hassiba Ben Bouali Chlef (UHBBC), Chlef, Algeria,
Nekkaz_mohamed@yahoo.fr

Dr. DJAHBAR Abdelkader

a_djahbar@yahoo.fr

Abstract: *The permanent magnet synchronous motors (PMSM) are recommended in the industrial world. This is because they are simple, reliable and less bulky than DC motors. This article studies the control problem of two permanent magnet synchronous five-phase machine (PMSM) connected in series and powered by a single inverter of five arms. We studied a system of two PMSM machine connected in series, we started by modelling the system and presents the independent vector control of the two five-phase PMSM connected in series and the results of simulations showed that the performance of this command. These performances were made by using the PI controllers.*

Keywords: *Multi machine system, five-phase permanent magnet synchronous machines (PMSM), vector control.*

1. Introduction

It is not possible to connect in series a number of three-phase machine feed them via a single three-phase inverter and independently control the speed of each machine. However, application of single multi-phase VSI (Voltage Single Inverter) in conjunction with multi-phase machines generates additional degrees of freedom [1]. This allows series connection of a number of multi-phase machines with appropriate phase transposition between each machine. The most important property of a multi-phase machine is that when the modeling is completed, a new set of equations will be obtained in which on two components (d-q) will lead to stator to rotor coupling, while the rest do not give coupling [2] If the number of phases is assumed to be an odd number, then for an n-phase machine there are, apart from the two components that yield stator to rotor coupling (d-q), one zero sequence component and additional (n-3) components or (n-3)/2 pairs of components (termed further on x-y components) that do not lead to stator to rotor coupling [3]. Vector control enables independent control of flux and torque of an AC machine by means of two stator

current components (one component pair) only (d-q).

This leaves (n-3)/2 pairs of components as additional degrees of freedom [4]. Hence, if it is possible to connect stator windings of (n-1)/2 machines (that are all in general n-phase) in such a way that what one machine sees as the d-q axis current components the other machines see as x-y current components, and vice versa, it would become possible to completely independently machines while supplying the machines from a single voltage source inverter.

Different works had treated serial connected multi-machine problem as [3] and [5] where a two synchronous multi-machine model was presented; in this work we present a two permanent magnet synchronous machine (PMSM) model.

In this paper, five-phase machines as an example, it is possible to independently realize of two five-phase machines using a single five-phase voltage source inverter, provided that the stator windings of the two machines are connected in series and that an appropriate phase transposition is introduced so that the set of five-phase currents that produces rotating mmf in the first machine, does not produce rotating mmf in the second machine and vice versa [5]-[12].

2. Presentation system two five-phase PMSM in series

The two-motor drive system under consideration is shown in Fig. 1. It consists of a five-phase source, two five-phase synchronous permanent magnet machine PMSM. The two machines are connected in series according to the diagram in Fig. 1 [3]. The five-phase machine has the special displacement between any two consecutive stator phases equal to $2\pi/5$ [4].

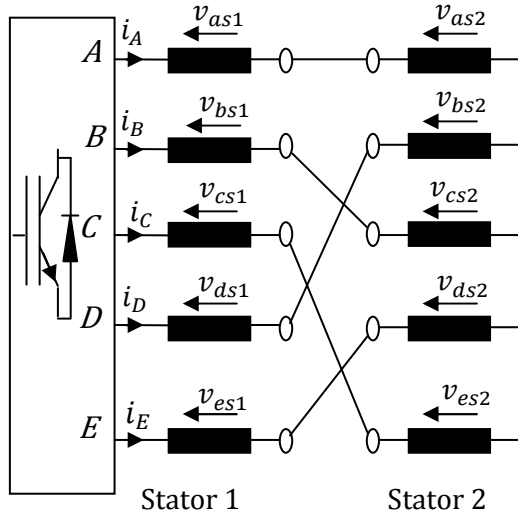

Fig. 1. A five-phase synchronous permanent magnet machine PMSM series-connected two-motor drive.

According to the connection diagram of Fig. 1, source phase to neutral voltages are determined with:

$$\begin{aligned} v_A &= v_{as1} + v_{as2} \\ v_B &= v_{bs1} + v_{cs2} \\ v_C &= v_{cs1} + v_{es2} \\ v_D &= v_{ds1} + v_{bs2} \\ v_E &= v_{es1} + v_{ds2} \end{aligned} \quad (1)$$

Relationship between source currents and individual stator phase currents of the two motors is governed with:

$$\begin{aligned} i_A &= i_{as1} = i_{as2} \\ i_B &= i_{bs1} = i_{cs2} \\ i_C &= i_{cs1} = i_{es2} \\ i_D &= i_{ds1} = i_{bs2} \\ i_E &= i_{es1} = i_{ds2} \end{aligned} \quad (2)$$

The electrical sub-system's model of the drive in Fig. 1 can be given in matrix form with:

$$[V_{ABCDE}] = R_s [i_{ABCDE}] + \frac{d}{dt} [\Phi_{ABCDE}] \quad (3)$$

$$\begin{bmatrix} v_A \\ v_B \\ v_C \\ v_D \\ v_E \end{bmatrix} = \begin{bmatrix} R_s & 0 & 0 & 0 & 0 \\ 0 & R_s & 0 & 0 & 0 \\ 0 & 0 & R_s & 0 & 0 \\ 0 & 0 & 0 & R_s & 0 \\ 0 & 0 & 0 & 0 & R_s \end{bmatrix} \begin{bmatrix} i_A \\ i_B \\ i_C \\ i_D \\ i_E \end{bmatrix} + \frac{d}{dt} \begin{bmatrix} \Phi_A \\ \Phi_B \\ \Phi_C \\ \Phi_D \\ \Phi_E \end{bmatrix} \quad (4)$$

And

$$[\Phi_{ABCDE}] = [l_s][i_{abcde}] + [\Phi_{aiment}] \quad (5)$$

$$\begin{cases} [V_{s1}] = [R_{s1}][i_{s1}] + \frac{d}{dt} ([l_{s1}][i_{s1}] \\ \quad + [\Phi_{aiment1}]) \\ [V_{s2}] = [R_{s2}][i_{s2}] + \frac{d}{dt} ([l_{s2}][i_{s2}] \\ \quad + [\Phi_{aiment2}]) \end{cases} \quad (6)$$

And

$$\begin{aligned} [V_{s1}] &= \begin{bmatrix} v_{as1} \\ v_{bs1} \\ v_{cs1} \\ v_{ds1} \\ v_{es1} \end{bmatrix}; [V_{s2}] = \begin{bmatrix} v_{as2} \\ v_{bs2} \\ v_{cs2} \\ v_{ds2} \\ v_{es2} \end{bmatrix}; [i_{s1}] = \begin{bmatrix} i_{as1} \\ i_{bs1} \\ i_{cs1} \\ i_{ds1} \\ i_{es1} \end{bmatrix}; \\ [i_{s2}] &= \begin{bmatrix} i_{as2} \\ i_{bs2} \\ i_{cs2} \\ i_{ds2} \\ i_{es2} \end{bmatrix}. \end{aligned}$$

Vectors $[V_{s1}]$, $[i_{s1}]$, $[V_{s2}]$, $[i_{s2}]$ are respectively the voltages and the run of the first and second machine.

The Model Park your system can be deduced Clark transformation matrix is applied $C_{5 \times 5}$ the system of equations (I.4). Since the neutral of the two machines are isolated ($i_A + i_B + i_C + i_D + i_E = 0$), the model of Park expressed in the fixed coordinate system relative to the stator can be Currency into two orthogonal subspaces them (α - β) and (x - y) [7] [8].

CLARK transform matrix is:

$$[c] = \sqrt{\frac{2}{5}} \begin{bmatrix} 1 & \cos(\alpha) & \cos(2\alpha) & \cos(3\alpha) & \cos(4\alpha) \\ 0 & \sin(\alpha) & \sin(2\alpha) & \sin(3\alpha) & \sin(4\alpha) \\ 1 & \cos(2\alpha) & \cos(4\alpha) & \cos(6\alpha) & \cos(8\alpha) \\ 0 & \sin(2\alpha) & \sin(4\alpha) & \sin(6\alpha) & \sin(8\alpha) \\ \frac{1}{\sqrt{1/2}} & \frac{1}{\sqrt{1/2}} & \frac{1}{\sqrt{1/2}} & \frac{1}{\sqrt{1/2}} & \frac{1}{\sqrt{1/2}} \end{bmatrix} \quad (7)$$

And the inverse of this matrix is:

$$[c]^T = \sqrt{\frac{2}{5}} \begin{bmatrix} 1 & 0 & 1 & 0 & \frac{1}{\sqrt{1/2}} \\ \cos(\alpha) & \sin(\alpha) & \cos(2\alpha) & \sin(2\alpha) & \frac{1}{\sqrt{1/2}} \\ \cos(2\alpha) & \sin(2\alpha) & \cos(4\alpha) & \sin(4\alpha) & \frac{1}{\sqrt{1/2}} \\ \cos(3\alpha) & \sin(3\alpha) & \cos(6\alpha) & \sin(6\alpha) & \frac{1}{\sqrt{1/2}} \\ \cos(4\alpha) & \sin(4\alpha) & \cos(8\alpha) & \sin(8\alpha) & \frac{1}{\sqrt{1/2}} \end{bmatrix} \quad (8)$$

We have:

$$\begin{cases} [V_{\alpha\beta xy01}] = [R_{s1}][i_{\alpha\beta xy01}] \\ \quad + [c_5]\{[l_{s1}][C_5]^{-1} \frac{d}{dt} [i_{\alpha\beta xy01}] + [\Phi_{aiment1}]\} \\ [V_{\alpha\beta xy02}] = [R_{s2}][i_{\alpha\beta xy02}] \\ \quad + [c_5]\{[l_{s2}][C_5]^{-1} \frac{d}{dt} [i_{\alpha\beta xy02}] + [\Phi_{aiment2}]\} \end{cases} \quad (9)$$

The order of zero for the inverter component may be either neglected. The electromagnetic part of the

drive system can then be represented with eight first order equations. The four equations of the inverter are as follows [9]:

$$\begin{cases} v_{\alpha}^{inv} = (R_{s1} + R_{s2})i_{\alpha}^{inv} - \sqrt{\frac{5}{2}}\omega_1\phi_{f1}\sin(\theta_1) \\ \quad + (l_{s1} + l_{s2} + \frac{5}{2}m_{s1})\frac{d}{dt}i_{\alpha}^{inv} \\ v_{\beta}^{inv} = (R_{s1} + R_{s2})i_{\beta}^{inv} + \sqrt{\frac{5}{2}}\omega_1\phi_{f1}\sin(\theta_1) \\ \quad + (l_{s1} + l_{s2} + \frac{5}{2}m_{s1})\frac{d}{dt}i_{\beta}^{inv} \\ v_x^{inv} = (R_{s1} + R_{s2})i_x^{inv} - \sqrt{\frac{5}{2}}\omega_2\phi_{f2}\sin(\theta_2) \\ \quad + (l_{s1} + l_{s2} + \frac{5}{2}m_{s2})\frac{d}{dt}i_x^{inv} \\ v_y^{inv} = (R_{s1} + R_{s2})i_y^{inv} + \sqrt{\frac{5}{2}}\omega_2\phi_{f2}\sin(\theta_2) \\ \quad + (l_{s1} + l_{s2} + \frac{5}{2}m_{s2})\frac{d}{dt}i_y^{inv} \end{cases} \quad (10)$$

For the model in space (d-q) and (x-y), rotational transformation matrix is applied $[D_s]$ for voltage of the inverter (I.7) [10] [11]:

$$[D_s] = \begin{bmatrix} \cos(\theta) & -\sin(\theta) \\ \sin(\theta) & \cos(\theta) \end{bmatrix} \quad [I]^{3 \times 3} \quad (11)$$

The equations of the system with two synchronous machines pentaphasées permanent magnet connected in series in space (d-q) and (x-y) are:

$$\begin{cases} v_d = (R_{s1} + R_{s2})i_d - \omega_1 \left(l_{s1} + \frac{5}{2}m_{s1} \right) i_q \\ \quad + \left(l_{s1} + l_{s2} + \frac{5}{2}m_{s1} \right) \frac{d}{dt}i_d \\ v_q = (R_{s1} + R_{s2})i_q + \omega_1 \left(l_{s1} + \frac{5}{2}m_{s1} \right) i_d \\ \quad + \left(l_{s1} + l_{s2} + \frac{5}{2}m_{s1} \right) \frac{d}{dt}i_q + \sqrt{\frac{5}{2}}\omega_1\phi_{f1} \\ v_x = (R_{s1} + R_{s2})i_x - \omega_2 \left(l_{s2} + \frac{5}{2}m_{s2} \right) i_y \\ \quad + \left(l_{s1} + l_{s2} + \frac{5}{2}m_{s2} \right) \frac{d}{dt}i_x \\ v_y = (R_{s1} + R_{s2})i_y + \omega_2 \left(l_{s2} + \frac{5}{2}m_{s2} \right) i_x \\ \quad + \left(l_{s1} + l_{s2} + \frac{5}{2}m_{s2} \right) \frac{d}{dt}i_y + \sqrt{\frac{5}{2}}\omega_2\phi_{f2} \end{cases} \quad (12)$$

ϕ_{f1} : Total Cash Flow due to magnets and closes on the stator 1.

ϕ_{f2} : Total Cash Flow due to magnets and closes on the stator 2.

Couple relations between the two series-connected

machines are given in terms of current components of the inverter:

$$C_{em1} = p \left((l_d - l_q)i_d l_q + \sqrt{\frac{5}{2}}\phi_{f1}i_q \right) \quad (13)$$

$$C_{em2} = p \left((l_x - l_y)i_x l_y + \sqrt{\frac{5}{2}}\phi_{f2}i_y \right) \quad (14)$$

And the equations of the two machines speeds are:

$$J_{m1} \frac{d\Omega_1}{dt} = T_{e1} - T_{r1} - f_{m1}\Omega_1 \quad (15)$$

$$J_{m2} \frac{d\Omega_2}{dt} = T_{e2} - T_{r2} - f_{m2}\Omega_2 \quad (16)$$

3. The independent control of series-connected two five phase machine

The objective is to achieve independent control of all polyphase machines in the group while using a single voltage inverter. An independent vector control is allowed using a suitable connection in series of motor stator windings and polyphase vector control principles. [12] The fundamentals of emerging concept that the polyphase machine only requires two currents for controlling flow and torque.

The two equations (v_d and v_x) are completely independent, so we can control each machine with a dedicated vector control and using a single inverter. [12]

Among the control strategies, one that is often used is to maintain the components i_d and i_x null. We control couples only by i_q and i_y as shown in Fig.2.

The independent vector control of two five phases PMSM have the same scheme as one five phases PMSM.

The only difference is that we should calculate the tension X-Y in function of Park current to be added to the tension d-q to get the reference tension witch feed the inverter.

Overall voltage references are then formed on the wiring diagram of Fig.1 base, as follows:

$$\begin{cases} v_A^* = v_{as1}^* + v_{as2}^* \\ v_B^* = v_{bs1}^* + v_{cs2}^* \\ v_C^* = v_{cs1}^* + v_{es2}^* \\ v_D^* = v_{ds1}^* + v_{bs2}^* \\ v_E^* = v_{es1}^* + v_{ds2}^* \end{cases} \quad (17)$$

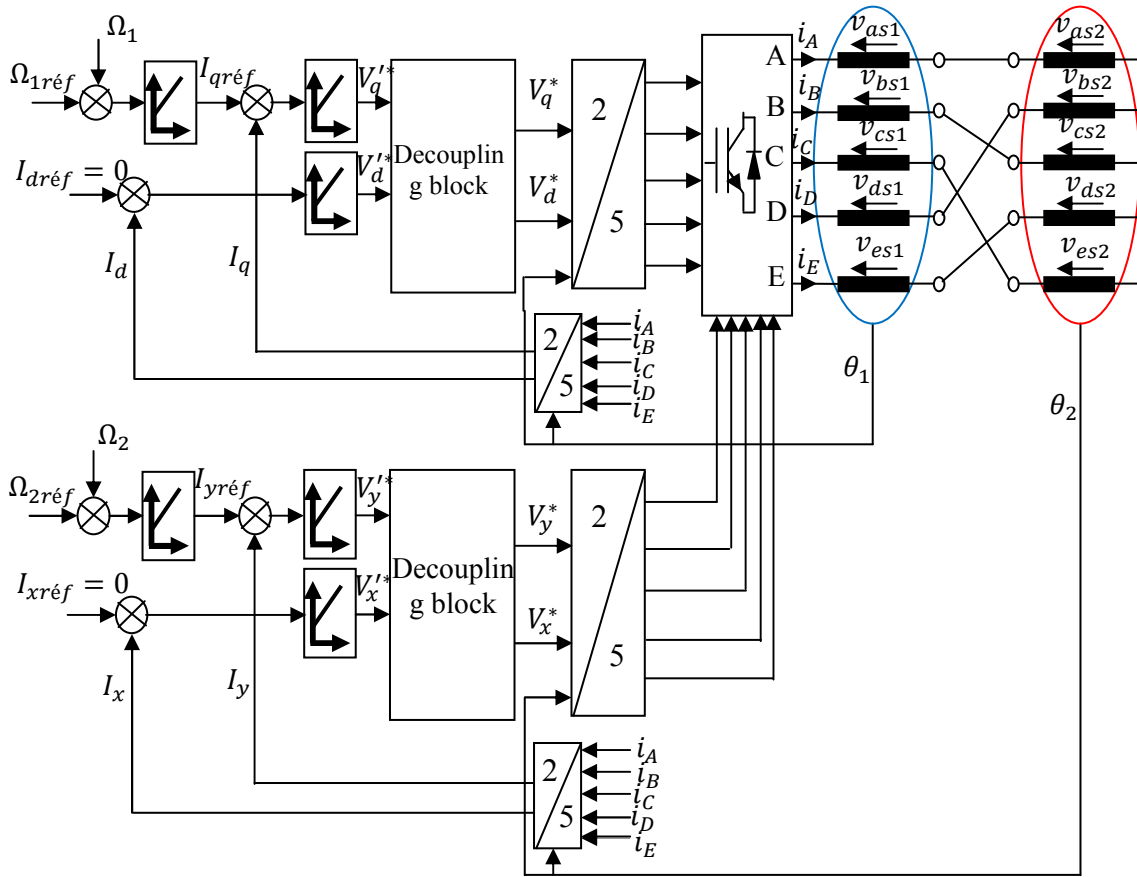

Fig. 2. Block diagram of vector control two five phase PMSM.

4. SIMULATION RESULTS

Simulation results are adopted in testing, with idea of proving the decoupling of control of the two machines. Parameters and rating of all the machines involved are taken as equal on a per-phase basis and are available in the appendix.

A speed transient is initiated next for either the first machine or the second machine, while the operating speed of other machine remains unchanged. Full decoupling of control will exist if and only if the speed and, more importantly, torque reference of the machine whose speed reference has not been altered do not change.

The transients examined in these simulations are acceleration and step loading transients.

In the first test, the first machine runs at 1500 rpm (in the direct direction), while the speed reference of the second machine is 750 rpm. The load torque applied to the first machine is 100 % of the rated torque at $t=0.5s$. It is evident from Figs.3-4-5-6 that step loading of the first machine does not cause any disturbance in the second machine's speed and torque references traces.

In the second test, the first machine runs at 1500 rpm (in the direct direction), while the speed reference of the second machine is 750 rpm. The load torque applied to the second machine is 100 % of the rated torque at $t=1.5s$. It is evident from Figs.7-8-9-10 that step loading of the second machine does not cause any disturbance in the first machine's speed and torque references traces.

In the third test, the first machine runs at 1500 rpm then at -1500rpm at $t=0.9s$, while the speed reference of the second machine is 750 rpm. The load torque applied to the first machine is 100 % of the rated torque at $t=0.5s$. And the first machine runs at 1500 rpm, while the speed reference of the second machine is 750 rpm then at -750 rpm at $t=1.2s$. The load torque applied to the first and second machine is 100 % of the rated torque. It is evident from Figs.11-12-13-14 and Figs.15-16-17-18 that step loading of the second machine does not cause any disturbance in the first machine's speed and torque references traces.

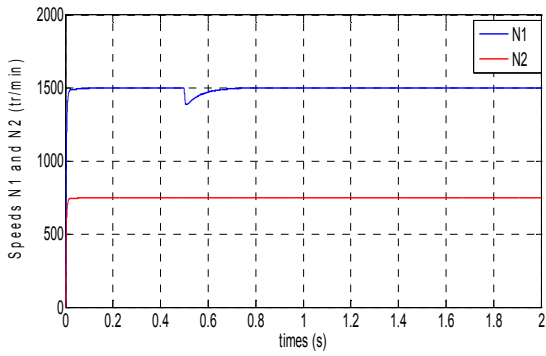

Fig. 3. Speeds of the first machine M1 runs at 1500 rpm and the load torque applied at $t = 0.5s$ ($TL = 5N.m$) and second machine M2 runs at 750 rpm.

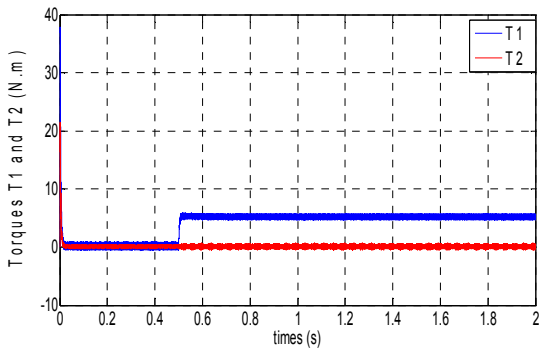

Fig. 4. Torques of the first and second machines.

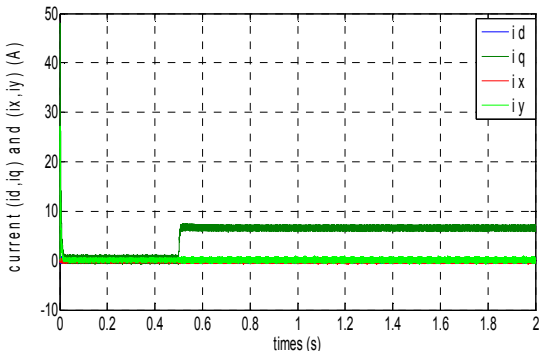

Fig. 5. Currents of the first and second machines.

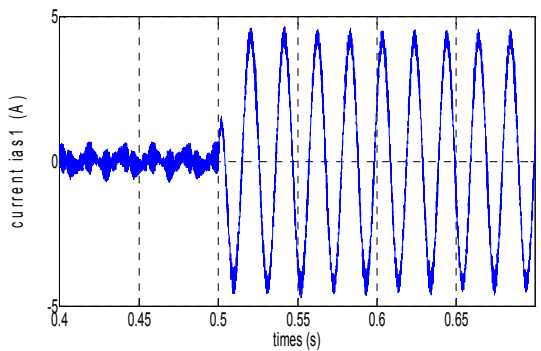

Fig. 6. Current in one phase of the first machine.

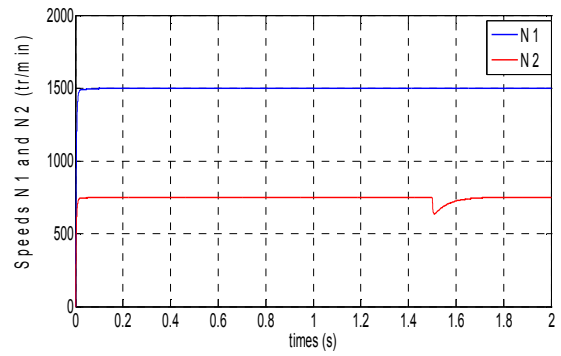

Fig. 7. Speeds of the first machine M1 runs at 750 rpm and the load torque applied at $t = 1.5s$ ($TL = 5N.m$) and second machine M2 runs at 750 rpm.

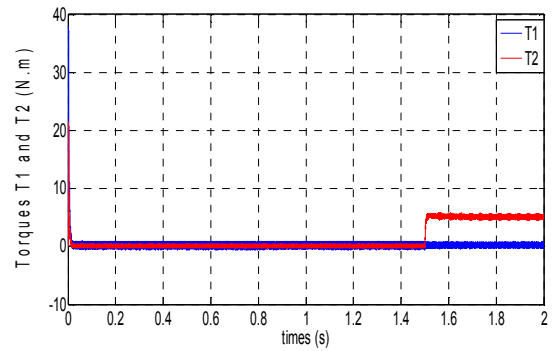

Fig. 8. Torques of the first and second machines.

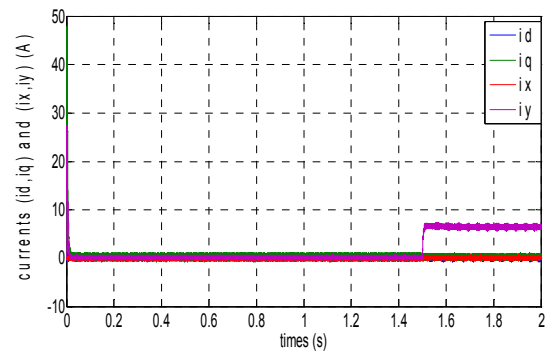

Fig. 9. Currents of the first and second machines.

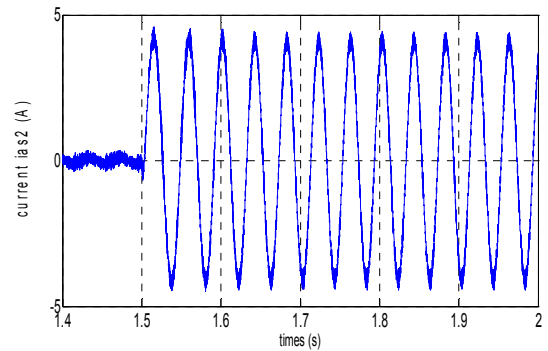

Fig. 10. Current in one phase of the second machine.

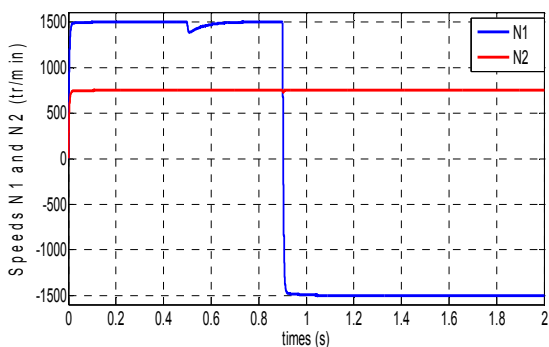

Fig. 11. Speeds of the first machine runs at 1500 rpm and -1500 rpm at $t=0.9s$, and speed second machine runs 750 rpm.

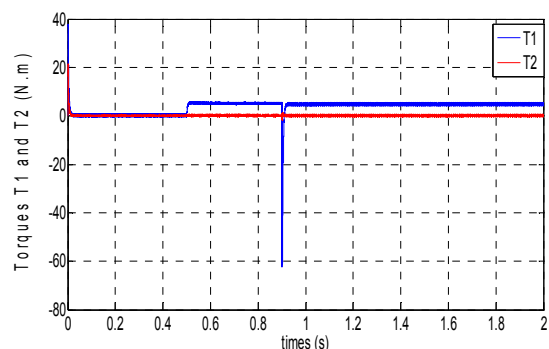

Fig. 12. Torques of the first and second machines.

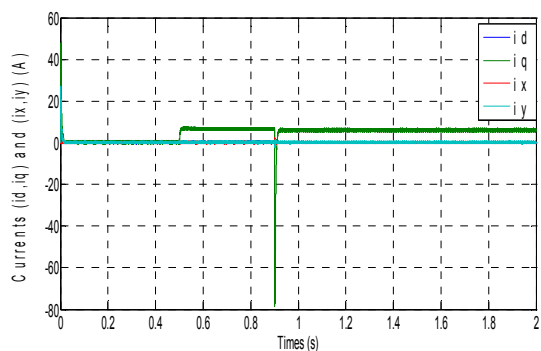

Fig. 13. Currents of the first and second machines.

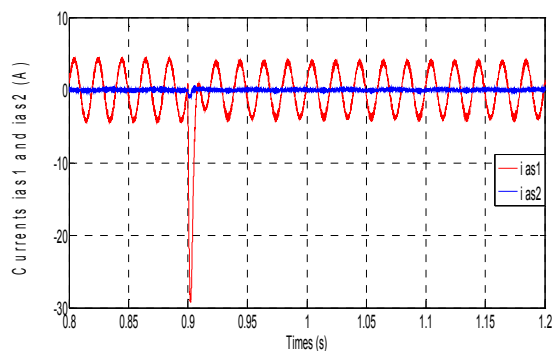

Fig. 14. Current in one phase of the first and second machine.

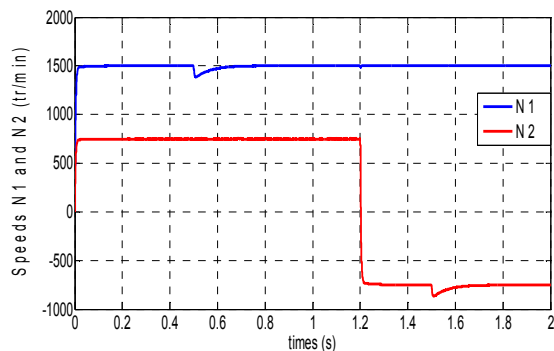

Fig. 15. Speeds of the first machine runs at 1500 rpm, and speed second machine runs 750 rpm then -750 rpm at $t=1.2s$.

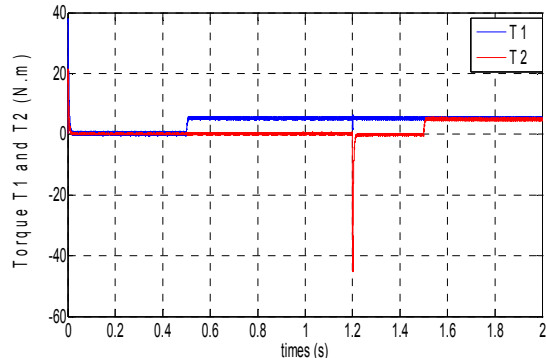

Fig. 16. Torques of the first and second machines.

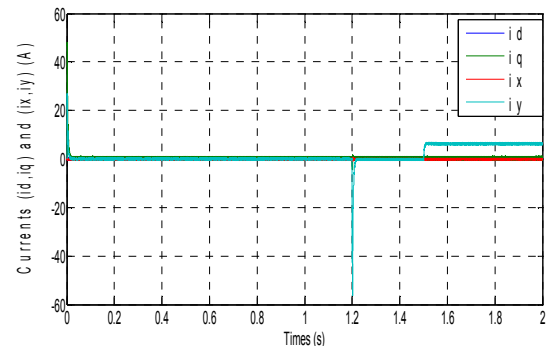

Fig. 17. Currents of the first and second machines.

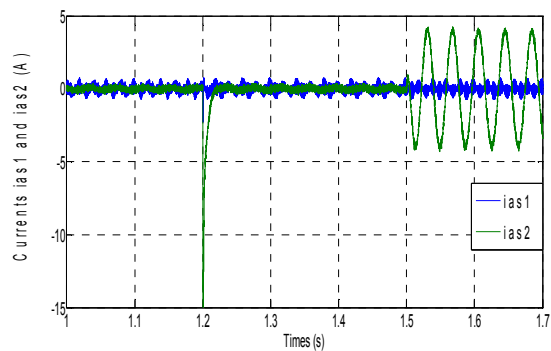

Fig. 18. Current in one phase of the first and second machine.

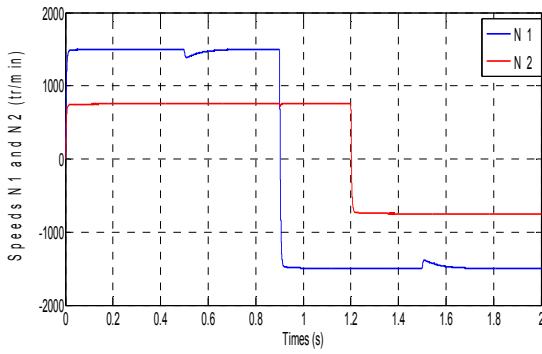

Fig. 19. Speeds of the first machine runs at 1500 rpm and -1500 rpm at $t=0.9s$, and speed second machine runs 750 rpm and -750 rpm at $t=1.2s$.

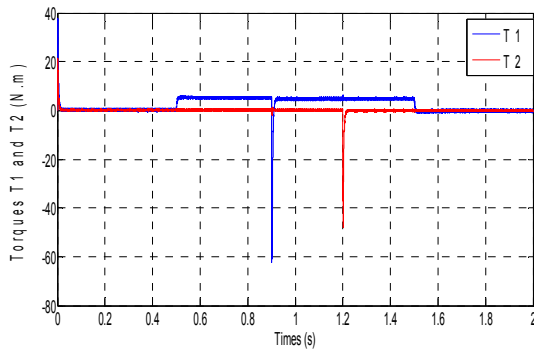

Fig. 20. Torques of the first and second machines.

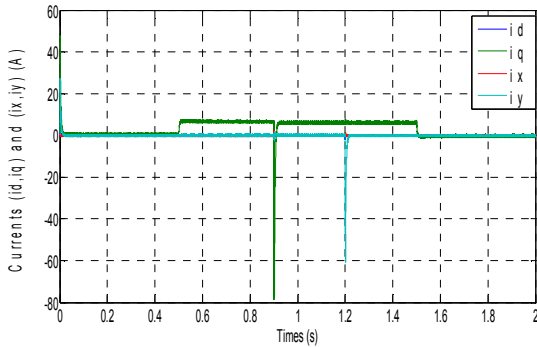

Fig. 21. Currents of the first and second machines.

5. CONCLUSIONS

This paper has analyzed a five-phase series-connected two synchronous permanent magnet machine drive system. The model was initially introduced and the detailed modeling procedure was transformation of the general theory of electrical machines and the d-q axis model was developed. Properties of this model are such that they unambiguously show the possibility of decoupled

vector control of the system, using a single five-phase inverter

The major drawback of the concept is an increase in the stator winding losses (and a considerably smaller increase in the stator iron losses) due to the flow of torque producing currents of all the machines through stator windings of all the machines (note that rotor winding losses are not affected). Similarly, stator iron losses will increase as well, due to the increased phase voltage of the individual machines caused by the flow of x-y current components.

APPENDIXES

Parameters of five-phase synchronous permanent magnet machine PMSM are:

$$R_{s1} = R_{s2} = 1 \Omega; l_{s1} = l_{s2} = 0.2 \text{ mH};$$

$$P_{1,2} = 2$$

$$l_d = 8.5 \text{ mH}; l_q = 8 \text{ mH};$$

$$J_{m1,2} = 11 * 10^{-3} \text{ kg} * \text{m}^2$$

$$f_{m1,2} = 0.0014 \text{ N} \cdot \frac{\text{m}}{\text{rad} * \text{sec}};$$

$$\Phi_{m1,2} = 0.175 \text{ Wb}$$

$$N_{1,2} = 1500 \text{ rpm}$$

References

1. H.A.Toliyat, H.Xu, L.J.Petersen, "Five-Phase Induction Motor Drives With DSP-Based Control System" IEEE Transactions on Power Electronics, Vol. 17, no. 4, pp.524- 533, July Atif Iqbal, "dynamic performance of vector-controlled five-phase synchronous reluctance motor drive: an experimental investigation" IET Elect. power, vol.05, April 2008.
2. E. Semail, E. Levi, A Bouscayrol, X. Kestelyn, "Multi-Machine modeling of Two series Connected 5-Phases synchronous Machines: Effect of harmonics on Control", IEEE-IAS'04, Seattle (Washington), Vol.1, pp.71-78, October 2004.
3. J. N. Verhille, A. Bouscayrol, P. J. Barre, J.C. Mercieca, J. P. Hautier, E. Semail, "Torque tracking strategy for anti-slip control in railway traction systems with common supplies", IEEE-IAS'04, Seattle (Washington), vol. 4. pp. 2738-2745, October 2004.
4. Atif Iqbal "Modeling and control of series connected five phase and six phase two motor drives" A thesis submitted in partial fulfilment of the requirements of Liverpool John Moores University for the degree of Doctor of Philosophy, August 2005.

5. M. Jones, E. Levi, "Combining Induction and Synchronous Machines in a Seven-Phase Series Connected Three-Motor Drive", EPE-PEMC'04, Riga (Latvia), CDROM, September 2004.
6. DIXON, J. W, CONTARDO, L M., MORÁN, L. A, "Fuzzy-Controlled Active Front-End Rectifiers with Current Harmonic Filtering Characteristics and Minimum Sensing Variables," IEEE Transactions on Power Electronics, Vol. 14, No. 4, pp. 724-729, 1999.
7. E. Levi, M. Jones, S.N. Vukosavic and H.A. Toliyat, "A novel concept of a multiphase, multi-motor vector controlled drive system supplied from a single voltage source inverter," IEEE Trans. Power Electronics, vol. 19, pp. 320-335, 2004.
8. E. Levi, M. Jones, and S. N. Vukosavic, "Even-phase multi motor vector controlled drive with single inverter supply and series connection of stator windings," IEE Proc. Electr. Power Appl., vol. 150, no. 5, pp. 580-590, 2003.
9. D.C. White, H.H. Woodson, "Electromechanical Energy Conversion," New York, NY: John Wiley and Sons, 1959.
10. M. Jones E. Levi, , S.N. Vukosavic ,H.A. Toliyat and atif iqbal "Modeling, Control and Experimental Investigation of a Five-Phase Series-Connected Two-Motor Drive with Single Inverter Supply," IEEE Trans. on Industry Applications, vol. 54, no. 3, June2007.
11. M. Jones E. Levi, , S.N. Vukosavic and H.A. Toliyat, "A five-phase two-machine vector controlled induction motor drive supplied from a single inverter," European Power Electronics (EPE) and Drives Journal, vol. 14, no. 3, pp. 38 48, 2004.
12. M. Jones E. Levi, , S.N. Vukosavic and H.A. Toliyat, "A five-phase two-machine vector controlled induction motor drive supplied from a single inverter," European Power Electronics (EPE) and Drives Journal, vol. 14, no. 3, pp. 38 48, 2004.