

INTELLIGENT MPPT CONTROLLER FOR PV SYSTEM USING GRAVITATIONAL SEARCH ALGORITHM

S.Joshibha Ponmalar¹, P.Valsala²

Assistant Professor¹, Department of Electrical and Electronics Engineering,
Saveetha Engineering College, Chennai.

lettertojoshi@yahoo.com

Professor², Department of Electrical and Electronics Engineering,
College of Engineering, Anna University, Chennai.

pvalsala@gmail.com

Abstract:

In this paper, for maximum power point tracking (MPPT) of photovoltaic (PV), the combination of gravitational search algorithm (GSA) and recurrent neural network (RNN) is proposed. Initially, the panel power, voltage, current and solar irradiance is considered for analysing the PV system. According to these parameters, the maximum power is tracked and generated the control signal for the converter. Here, the objective function is the minimisation of the

difference between the maximum power and the actual power. The proposed technique is implemented in Matlab/Simulink platform and their performances are evaluated under the variation of solar irradiance. Based on the solar irradiance, the performances are analysed in the different time instants and considered as the three different cases.

Keywords: PV panel, GSA, RNN, power, voltage, current and ANN

1. Introduction

The new generation scenario uses alternative and renewable electrical energy sources [1] that cause minimum ecological and economic impacts. Many countries have turned to new forms of green energy called “renewable energy” that are currently too expensive and relatively inefficient [2]. An alternative energy source has been widely used because it is pollution free, abundant, and broadly available [3-6]. Among the renewable energy sources photovoltaic (PV) energy seems to be the most promising source. The PV generation systems have two major problems: the conversion efficiency of electric power generation is low, and the amount of electric power generated by solar arrays changes continuously with weather conditions [7]. In general, there is a unique point on the current–voltage I–V or power–voltage P–V curve of a photovoltaic array where the output power from the array has a maximum value

[8, 9]. As the Maximum Power Point (MPP) of a PV power generator depends on array temperature and irradiance, in order to maximise the energy delivered by the PV array it is necessary to track the MPP continuously [10-12].

Typically, the maximum power point (MPP) is achieved by adjusting the operating point of the PV array using a DC–DC converter [13]. To date, numerous MPPT algorithms are reported in the literature; they are broadly classified into two categories, namely (1) the conventional and (2) soft computing methods. To alleviate some of the problems available in the conventional techniques, the MPPT techniques based on soft computing (SC) are proposed [14, 15]. The detailed description of the proposed technique is presented in Section 3. Prior to that, the problem definitions based on recent research works are presented in Section 2. The experimental results and discussion are given

in Section 4. Finally, the Section 5 concludes the paper.

2. Problem Statement

The generic review shows that, the tracking method plays an important role to deliver maximum power from grid connected PV system. In order to extract maximum power, PV module must be operated at the voltage corresponding to the MPP. Numerous MPPT methods are existed in literature are inadequate by the difficulty in the measurements of PV temperature and irradiation characteristics and they fail miserably in solving certain variant optimization problems. They require a large number of iterations to optimize the solutions thereby leading to increased computational cost. To overcome these problems, the need for an effective hybridization algorithm is keenly felt. Therefore, in this paper, an intelligent technique based MPPT is proposed for tracking the maximum power of PV system.

3. PV system model with proposed MPPT technique

The proposed MPPT technique is the intelligent technique, which is the combination of gravitational search algorithm (GSA) and recurrent neural network (RNN). This model is required for the calculation of the system performance and the determination of its performance parameters. As shown in Figure 1, the model of a photovoltaic system is mainly composed of the PV array of panels, the proposed MPPT Controller, the DC–DC converter and the grid connected inverter which is acting as a load. The PV panels are the power source, which supply the system with the DC power. The DC-DC converter boosts the input DC voltage into a desired DC value according to the value of its duty cycle. The proposed MPPT controller adjusts the duty cycle (D) of the DC-DC converter in order to keep the PV panels operating point, mostly at the MPP.

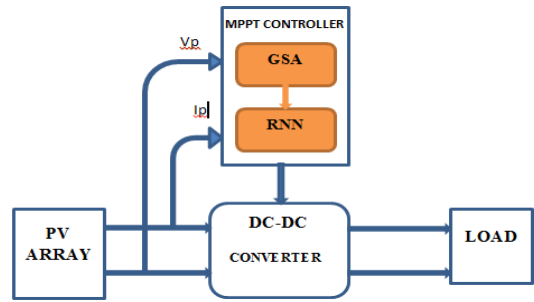

Figure.1: PV system model with proposed technique

3.1. PV array model

In this sub section, the detail description of PV cells are specified and illustrated in figure 2. The semiconductor panel absorbs photons from sunlight and releases electrons from atoms and so a potential difference is generated. This makes a current flow in the material to neglect the potential difference and hence the electricity is captured. An equivalent circuit of a PV cell is comprised of a current source, diode and resistors connected in both series and parallel model [18].

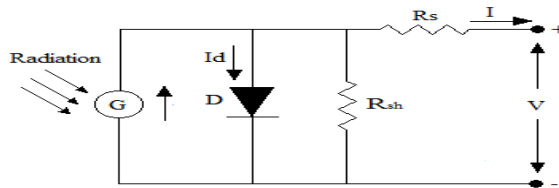

Figure.2: PV cell equivalent circuit

The PV cell current flow is described in the following equation ,

$$I_{pv} = \frac{I_{mp}}{1 - C^{-d}} \left[e^{\frac{V_{oc} + q(V+R_s I)}{m k T}} - e^{\frac{V_{oc}}{a}} \right] - \frac{V + R_s I}{R_{sh}} \quad (1)$$

For the above equation, the various factors are considered which are described as following,

q	-Electron charge ($1.6 \times 10^{-19} C$)
k	-Boltzmann's constan
T	-Temperature in K
N_s	-Number of cells of the module
V_{oc}	-Open circuit voltage
I_{mp}	-Current at maximum power
m	($1 < m < 3$)

- I -Current
 R_s -Series resistance

According to the irradiation ranges, solar panel models are stated and controlled. At a single instant, each solar panel can be operated at different irradiation levels between 600 W/m² and 1000 W/m² [14]. Based on the irradiation, the solar panel output power has been varied and it can be maintained at constant by using the proper control signals generation for the DC-DC converter.

3.2. Proposed Intelligent MPPT Controller

The proposed MPPT technique is the combination of gravitational search algorithm (GSA) and recurrent neural network (RNN). This section described in detail about training data generation using GSA and RNN based training of a general PV system.

3.2.1 GSA Based Training Dataset Generation

The training dataset generation has been explained in this section by means of the GSA method. GSA is a population based search algorithm, Based on the law of gravity and mass interaction. The algorithm regards as agents as objects containing of different masses [15]. The whole agents move due to the gravitational attraction force acting among them and the development of the algorithm directs the movements of all agents internationally towards the agents with heavier masses [16]. Here, the GSA technique is used to determine the MPPT training dataset of the RNN, which is attained by using the proposed objective function, i.e., minimization of difference between the current dc power and the maximum dc power. The DC voltage and current parameters of the solar panel is considered as the input of the GSA technique. Based on the variation of the voltage and current parameters, the control signals of the DC-DC converter have been decided by using the MPPT conditions. At the beginning the input agents are

DC voltage and current parameters are described in the following equation,

$$X_i^d = (V_{dci}, I_{dci})^d \quad (2)$$

Where, $(V_{dci}, I_{dci})^d = X_i^d$ defines the position of the i^{th} agent at d^{th} dimension. The dc voltage is randomly generated with the required n dimensions search space. The random generated agents are given in the following equation,

$$X_i^d = \begin{bmatrix} (V_{11}, I_{11}) & (V_{12}, I_{12}) & \dots & (V_{1n}, I_{1n}) \\ (V_{21}, I_{21}) & (V_{22}, I_{22}) & \dots & (V_{2n}, I_{2n}) \\ \vdots & \vdots & \vdots & \vdots \\ (V_{n1}, I_{n1}) & (V_{n2}, I_{n2}) & \dots & (V_{nn}, I_{nn}) \end{bmatrix} \quad (3)$$

From the agents the objective function can be calculated. The required objective function is given by the following relation,

$$\Phi = \text{Min} \{ P_k - P_m \} \quad (4)$$

Where, P_k is the current time DC power and P_m is the maximum output DC power. According to the Newton gravitational theory the total force acts on the agent is described in the following equation,

$$force_i^d(t) = \sum_{j \neq i} rand_j (force_j^d(t)) \quad (5)$$

Where,

$$F_{ij}^d(t) = G(t) \frac{M_i(t) * M_j(t)}{R_{ij} + \epsilon} * (X_j^d(t) - X_i^d(t)) \quad (6)$$

with, $R_{ij} = \|X_i(t), X_j(t)\|_2$ is the Euclidian distance between two agents i and j , $rand_j$ is the random values, i.e., $[0, 1]$, ϵ is a small constant, $G(t)$ is the gravitation constant at time t , M_{aj} and M_{pi} active and passive gravitational mass related to agent i and j . Here, the acceleration of the i^{th} agent can be determined by the following equation

$$\text{Acceleration } a_i^d(t) = \frac{force_i^d(t)}{M_i(t)} \quad (7)$$

Updating the agent's position, using the following velocity equation

$$V_i^d(t+1) = rand_i \cdot [V_i^d] + a_i^d(t) \quad (8)$$

The above velocity function is used to develop the new agents, which can be described in the following equation,

$$X_i^d(t+1) = X_i^d(t) + V_i^d(t+1)$$

Where, $V_i^d(t)$ and $X_i^d(t)$ are the velocity and position of an agent at t time and d dimension, $rand_i$ is the random number in the interval $[0, 1]$. The steps to find the MPPT training dataset is given in the following section.

Initialization process

In the initialization process, the searching space and dimension of the agent is defined. After that, generate the initial population of the dc voltage agents between minimum and maximum values of the voltage.

Evaluation process

(i) Fitness

Here, the objective function is considered as the fitness function, the fitness value of each agent is evaluated by utilizing the equation (4).

(ii) Mass

In the high mass, the agents are selected as the best solutions and the corresponding solution is stored in the memory.

Updating process

The best solutions are separated into two groups, the first groups have the best solutions and another group has worst solutions. For each best solution groups, the agent's positions and velocity is modified.

Ranking process

Evaluate the new agents. Select the best agent from each group. Repeat the steps 3-7 until the termination criteria are reached.

Termination process

Once the process is finished, the GSA is ready to give the training dataset for the RNN. The attained training dataset is utilized to train the RNN, which is briefly explained in the following section 3.2.2.

3.2.2. Process for Recurrent Neural Network training

RNN encloses two phases and four layers, such as, the training phase & testing phase and input layer, hidden layer, context layer & output layer, where 'n' neurons are applied in the unseen and context layer [17]. There is a one-step time delay in the feedback path so that earlier outputs of the unseen layer, moreover called the states of the network, are employed to compute novel output values. The preparing diagram of a RNN with voltages as input and one current as output is explained in Fig. 3.

The RNN has two inputs namely, voltage (V) and current (I). The output of RNN is control signal (DC), which is generated for regulating the pulses of converter. The RNN output is given to the DC-DC converter controller. Here, the input layer to hidden layer weights are specified as ($w_{11}, w_{12}, \dots, w_{1n}$, and $w_{21}, w_{22}, \dots, w_{2n}$). The arbitrary weights of recurrent layer and the output layer neuron are generated at the specified interval $[w_{min}, w_{max}]$. For every neuron of the input layer weight is allocated with the unity value. The RNN is trained by using back propagation through time delay (BPTT) algorithm with Bayesian regulation. The RNN process is based on the forward and backward

pass.

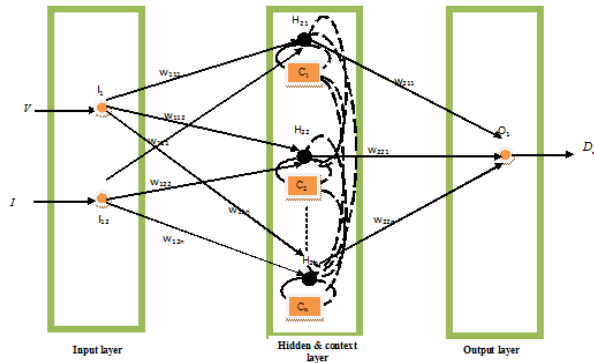

Figure 3: Training structure of proposed recurrent layer neural network

In this Bayesian Regularization technique, the objective function is modified by combining the mean sum of squared network errors and weights and makes a better working network by selecting exact combination. These are the processes involved in the Bayesian Regularization technique, which is a function with network training and based on Levenberg-Marquardt optimization, the weight and bias values are updated in this function.

$$Ed = \frac{1}{N} \sum_{i=1}^N ((Em)^2) \quad (11)$$

The well trained networks are obtained from the output of neural network process. The duty cycle is generated from this network. Then

the analysis of the proposed hybrid method is described in the following section.

4. Results and discussions

This section describes the performance of the proposed integrated technique implemented in MATLAB/SIMULINK working platform. In order to analyse the proposed hybrid control technique, PV system consist of Mono crystalline Silicon type solar panel Sunpower SPR-305 WHT is used. Figure 4 shows the PV system connected with the proposed control methodology. The performance analysis of the power of the PV is analysed based on the variation of the solar irradiance and temperature; the maximum output power is tracked. The generated power is usually provided to the nonlinear load by means of the transmission lines. Here, the control pulses generation of the converter is obtained by utilizing the proposed technique, which is based on the voltage and current of PV panel. The proposed method elegantly utilizes the voltage and current values of PV panel as the input. In the event the procedures come to an end, the GSA becomes well-gearred to generate the optimal control pulses of the converter.

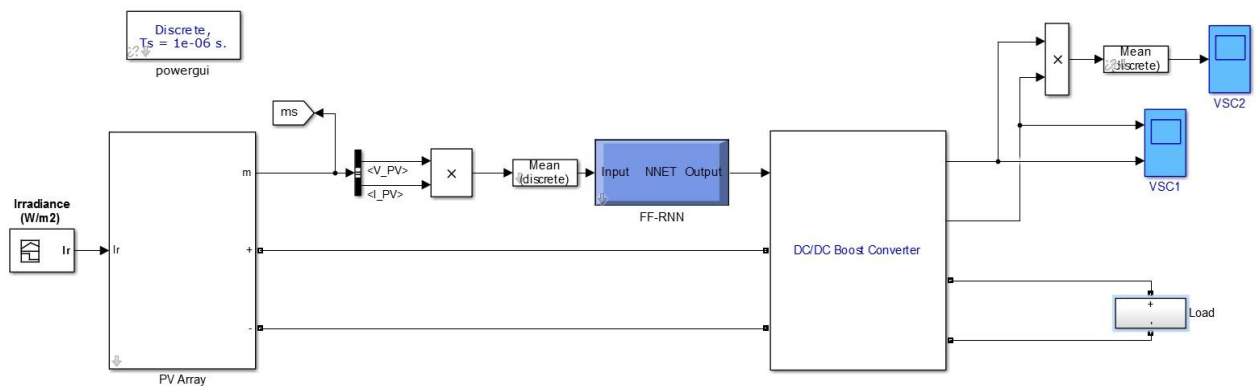

Figure 4: SIMULINK model of the proposed system

4.1. Performance analysis

4.1.1. Performance analysis at STC

. In this subsection, the performance evaluation of the proposed system and its simulation results are analysed for the change in solar irradiance and for different temperature. In order to determine the power output of the solar cell, it is important to determine the expected operating temperature of the PV module. Typical rating of a PV module will 25 °C under 1 kW/m² but in the fields, they typically operate at higher temperatures and at somewhat lower insolation conditions. The MPPT was controlled by using proposed GSA and RNN technique. While converter circuit uses predicted voltage and current control in order to have the optimal sinusoidal waveform. This system was simulated to learn the operation of the PV-grid connected system. Here, the proposed method is compared with the existing method such as IC technique and ANN technique. Initially, the panel irradiance, currents, voltage, and power are analysed in the normal typical conditions i.e. STC and illustrated in the figure 5 (a), (b), (c) and (d) respectively.

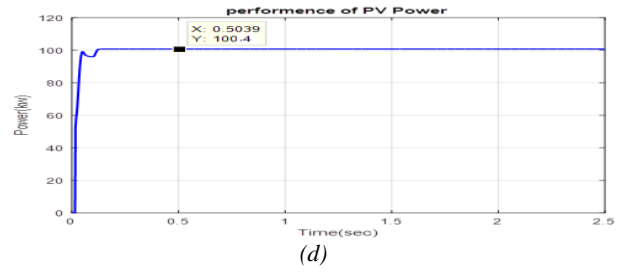
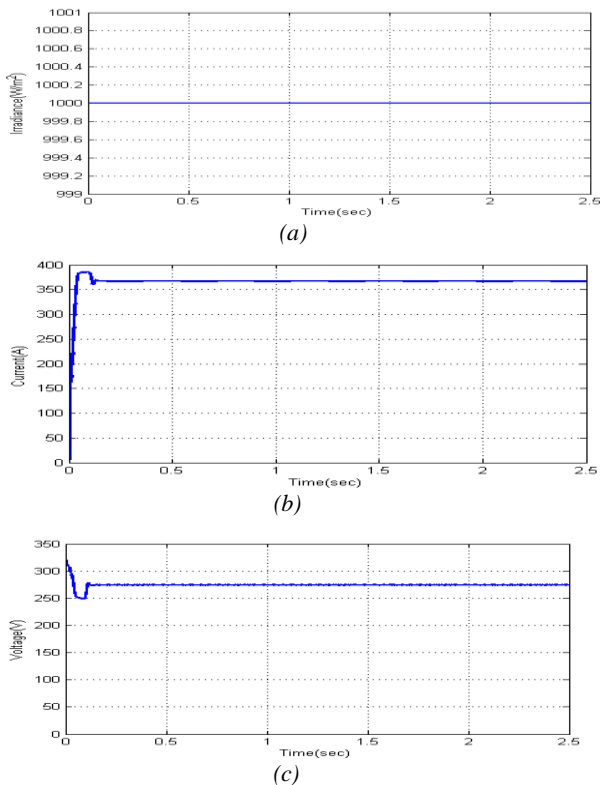

Figure 5: Performance analysis of PV panel at STC (a) irradiance (b) panel current (c) panel voltage and (d) power

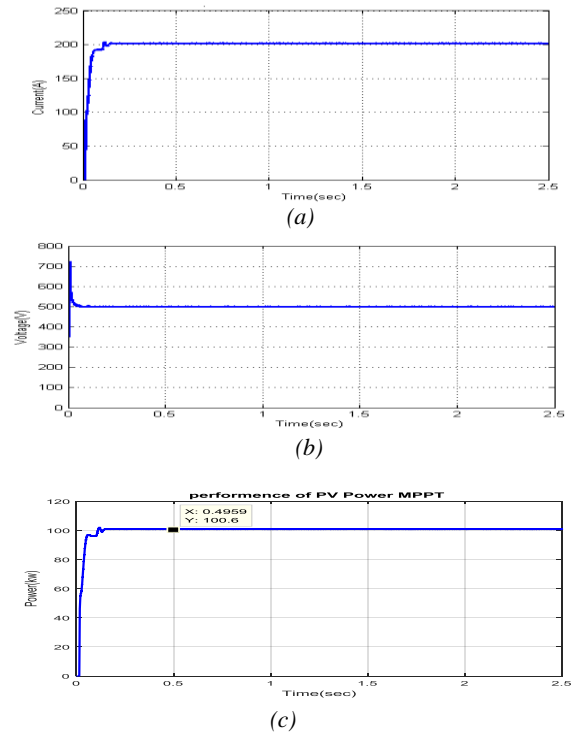
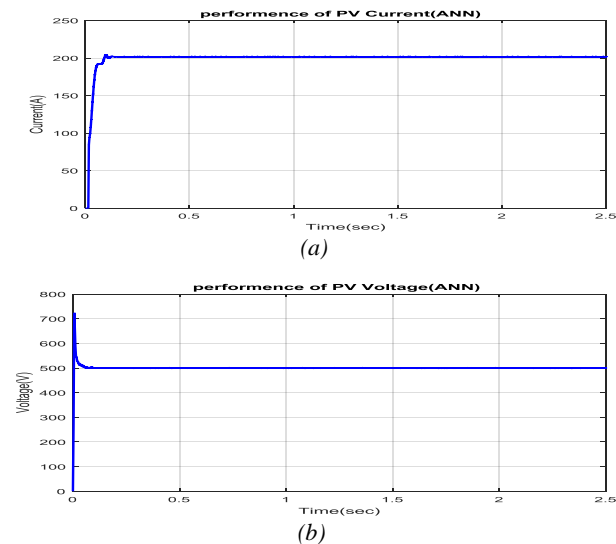

Figure 6: Performance analysis of PV Panel with Boost converter using Conventional MPPT technique (a) panel current (b) panel voltage and (c) power



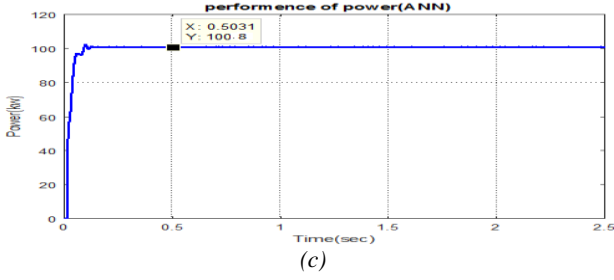

Figure 7: Performance analysis of PV Panel with Boost converter using ANN MPPT technique (a) panel current (b) panel voltage and (c) power

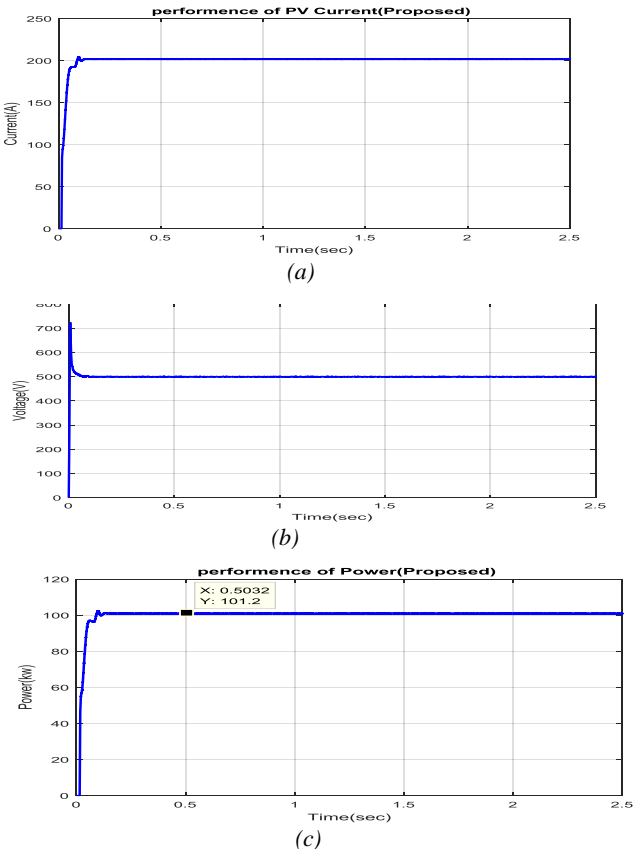

Figure 8: Performance analysis of PV Panel with Boost converter using proposed technique (a) panel current (b) panel voltage and (c) power

Figure 5 shows power management of the proposed model for the constant solar irradiance. The maximum tracking of the power are shown in figure 6, 7, 8 by using conventional MPPT technique, ANN technique and Proposed GSA base RNN technique. In which at time $t=0$ to 2.5 sec the maximum power of the proposed model is illustrated at the constant irradiance.

Table 1: Performance measures for different MPPT techniques at STC

Performance Measures at STC	Input	Output Using Different MPPT Algorithm's		
		Incremental Conductance	ANN Algorithm	GSA based RNN Algorithm
Voltage(V)	275	500	500	500
Current(A)	370	200	200	200
Power(kW)	100.9	100.6	100.8	101.2

The test results from the models reveal the performance and the precision of the used algorithms. Here, the control pulses generation of the converter is obtained by utilizing the various techniques such as IC, ANN, GSA based RNN, which is based on the voltage and current of PV panel. The proposed method elegantly utilizes the voltage and current values as the input and generates the optimal control pulses of the converter. Though the change in maximum power is very less compare to other MPPT techniques, the proposed method yield maximum output power within less time. Hence the hybrid GSA based RNN model has proven to be an effective way for Maximum power tracking and increase the efficiency of the system.

To validate the proposed algorithm the Maximum power point tracking is analysed under various PV irradiance and the different temperature. These performances are analysed in the different cases such as, Case A and Case B respectively. The analysed outputs of the proposed method are compared with IC technique and ANN technique.

4.1.2. Case A-Performance analysis at partial shading condition at 25° C

In this section, the PV voltage, current and irradiance are analysed in the partial shading condition with 25° C which are illustrated in the figure 9, 10, 11 and 12.

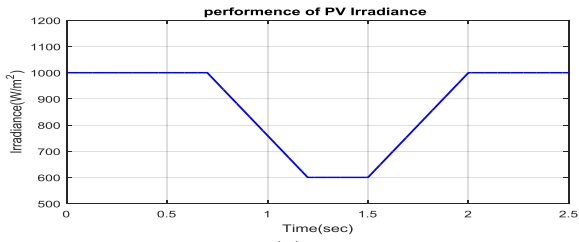

(a)

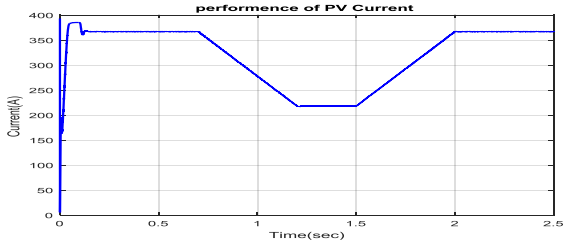

(b)

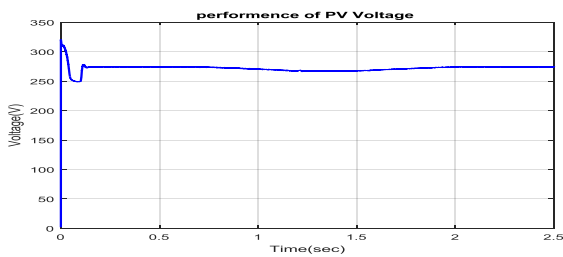

(c)

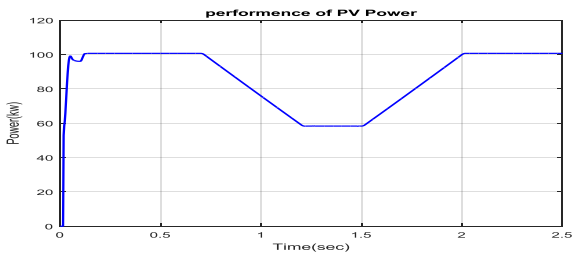

(d)

Figure 9: Performance analysis of PV panel at 25°C (a) irradiance (b) panel current (c) panel voltage and (d) power

As observed from this figure the solar irradiance is varied that is decreased about 60% from its normal irradiance due to partial shading effect. The power output is increased based on the MPPT working performance, if the MPPT control technique is not working properly, then the power is not maximised properly.

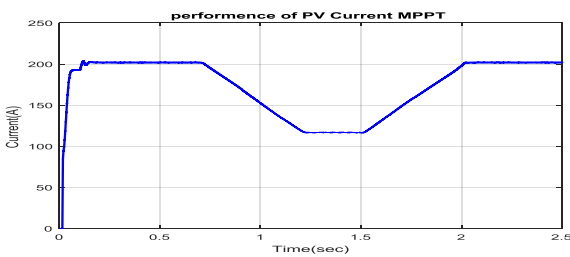

(a)

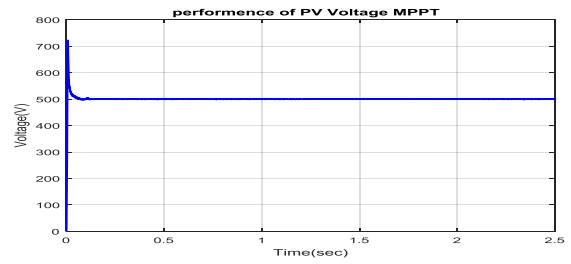

(b)

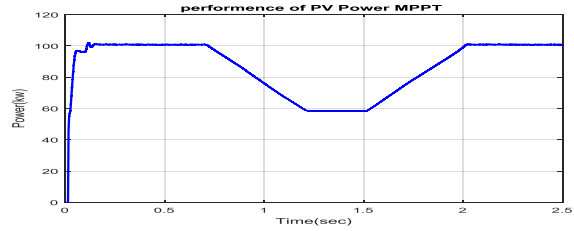

(c)

Figure 10: Performance analysis of PV Panel with Boost converter using Conventional MPPT technique (a) panel current (b) panel voltage and (c) power

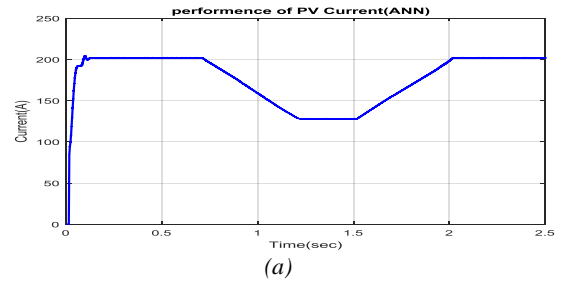

(a)

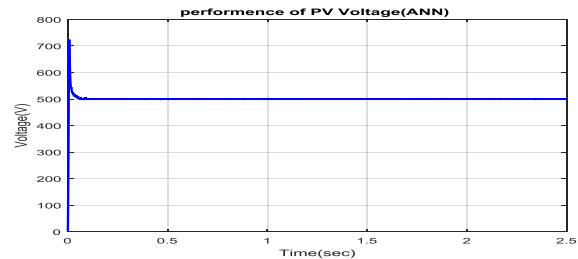

(b)

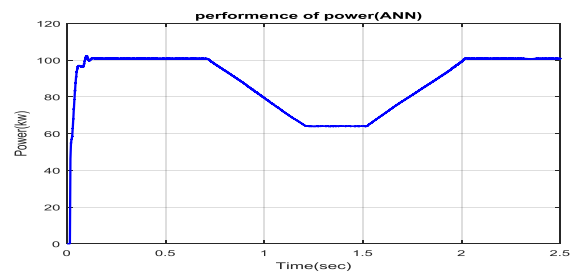

(c)

Figure 11: Performance analysis of PV Pane with Boost converter I using ANN technique (a) panel current (b) panel voltage and (c) power

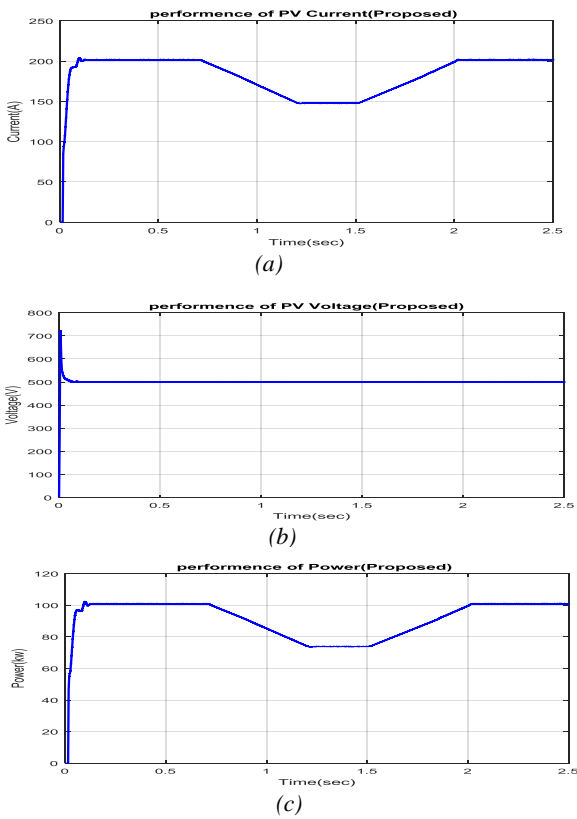

Figure 12: Performance analysis of PV Panel with Boost converter using proposed technique (a) panel current (b) panel voltage and (c) power

By using the proposed technique, the maximum power is achieved which is shown in the figures. From the above illustrations, the performance of maximum power tracking is analysed by using proposed and existing technique like IC and ANN techniques. Here, the solar irradiance is decreased about 60% of original values, after that applying the MPPT control techniques, the maximum power is achieved. Figure 10 shows that the performance analysis of varying solar irradiance is less in the conventional technique of tracking of maximum power of a PV system.

4.1.2. Case B-Performance analysis at partial shading condition at 40° C

In this sub section, to show the robustness and reliability of our proposed technique, we test its ability to track the MPP in different conditions of varying insolation and temperature. The

performance of power, voltage and current are analysed in the varying solar irradiance condition of the PV system with 40°C, by using the proposed and existing MPPT control techniques. The outputs are illustrated in the following figures 14, 15, and 16 respectively.

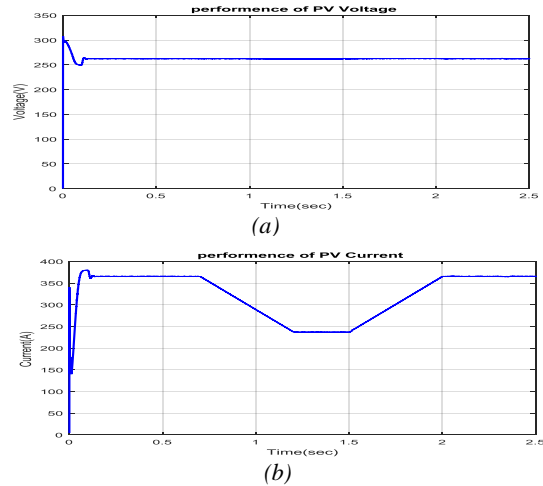

Figure 13: Performance analysis of PV panel at 40°C (a) panel voltage and (b) panel current

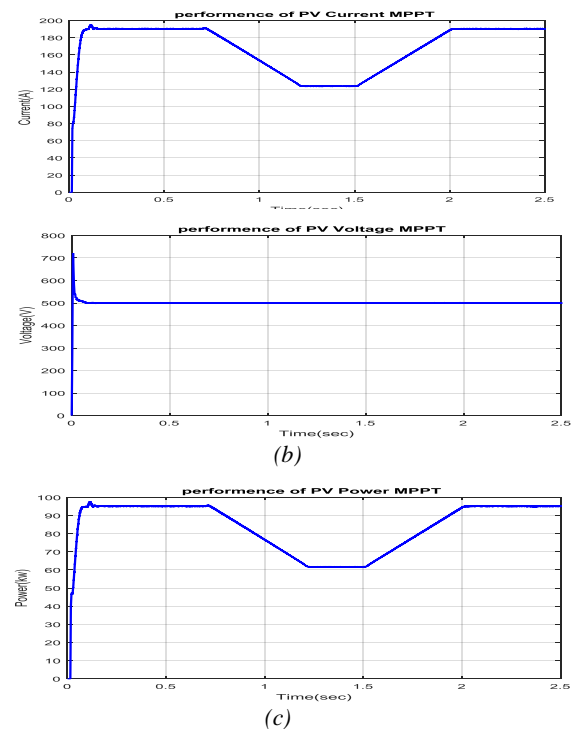

Figure 14: Performance analysis of PV Panel with Boost converter using Conventional MPPT technique (a) panel current (b) panel voltage and (c) power

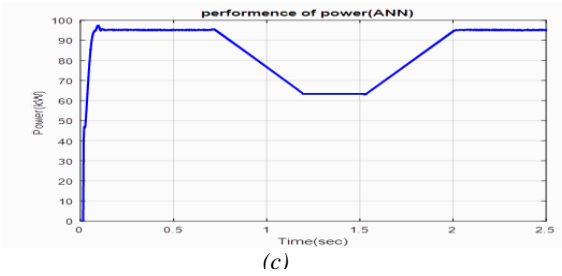
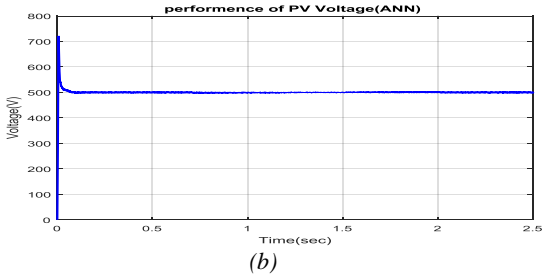
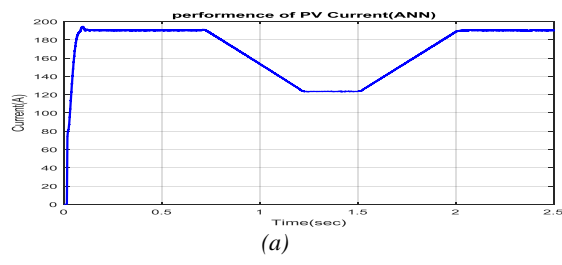

Figure 15: Performance analysis of PV Pane with Boost converter l using ANN technique (a) panel current (b) panel voltage and (c) power

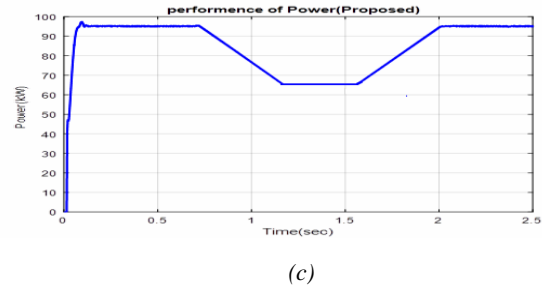
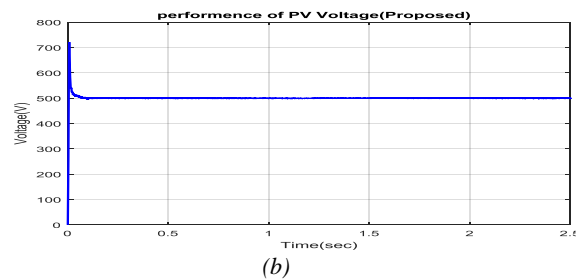
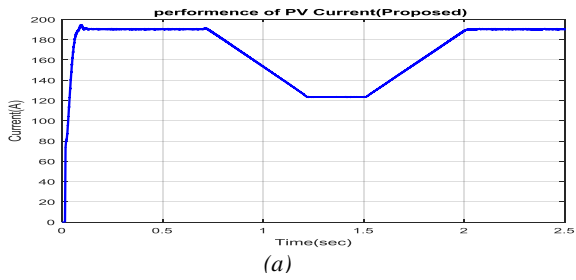

Figure 16: Performance analysis of PV Panel with Boost converter using proposed technique (a) panel current (b) panel voltage and (c) power

Table 2: Performance measures for different MPPT techniques under partial shading condition

Performance Measures	Input		Output Using Different MPPT Algorithm's					
	Case A 25°C	Case B 40°C	Incremental Conductance		ANN		GSA based RNN	
			Case A	Case B	Case A	Case B	Case A	Case B
Voltage (V)	320-275-272	307-263-264	500-498-500	500-498-500	500-499-500	500-499-500	500.5-500-500.5	500.5-500-500.5
Current (A)	370-220-370	375-237-375	200-122-200	189-124-189	200-137-200	189-124-189	200-149-200	214-153-214
Power (kW)	100-58-100	94-62-95.5	100.6-59-100.6	93-62-93	100.8-63-100.8	94-64-94	101-76-101	95-67-96

From the above comparison analysis of solar module Sunpower SPR-305WHT for various temperatures namely 25°C and 40°C, the open circuit voltage of PV solar cell decreases with increasing temperature in the cell indicated in figures, and the peak power decreases as the temperature increases. To study the performance of proposed MPPT technique we set the temperature and change the irradiance from small to large values. It can be seen from above simulation results mentioned in figures and table; the proposed algorithm has a good tracking in case of temperature variation. The accuracy of the proposed algorithm is confirmed. Hence the proposed algorithm addresses the challenges associated with rapidly changing insolation levels.

5. Comparison analysis

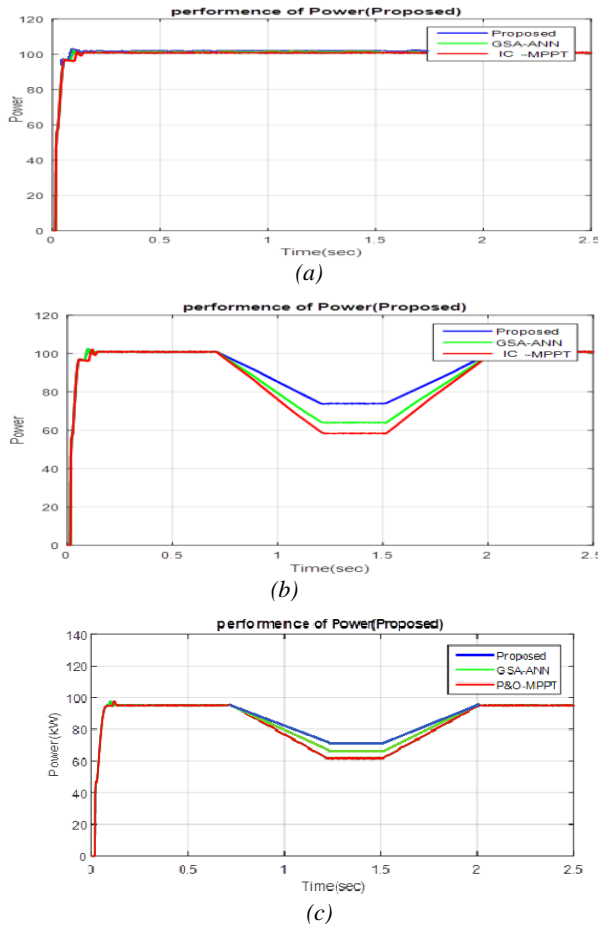

Figure 17: Comparison analysis of performance at (a) STC (b) Case A and (c) Case B using various methods

Here, the comparison analysis of the proposed and existing methods is analysed in the three different cases. The performances of power graph is illustrated and compared with the existing method in three cases. Here, the maximum power can be tracked by using the proposed MPPT controller and the existing controller such as IC and ANN technique. By the proposed technique, the power is almost achieved to the maximum level under all the cases. The power graphs are observed from the figure 17 (a), (b), (c) after the proposed method. In the Case A, the time instant $t=0.75$ to 2 sec, the power is tracked under the varying PV irradiance. With IC technique, the power curve of PV is initially increased 100.6kW at time instant $t=0.001$ sec. From $t=1$ sec, the output curve starts to decrease slowly and reaches the regulated power (59kW)

after $t=0.02$ sec. After that, the curve is increased at the time instant $t= 2.1$ sec. While using the ANN technique, initially the curve reaches the power at a high rate at $t=0.01$ sec. Then it is suddenly reduced to 62kW at $t=1.5$ sec. Again the curve starts to increase and obtained its regulated power of 100.8kW at $t=2$ sec even though there is a slight decrease at $t=2.1$ sec. In our proposed technique, initially increased 101.2kW at time instant $t=0.001$ sec. From $t=1$ sec, the output curve starts to decrease slowly and reaches the regulated power (79kW) after $t=0.02$ sec and again the curve starts to increase and obtained its regulated power of 101.2kW at $t=2$ sec. After reaching the maximum power, the curve goes constantly. Similarly, the other cases are analysed and compared with the existing methods. It is observed that, the proposed method has higher efficiency and accuracy than the other existing methods under partial shading conditions. The general observations are listed below in the table for clear understanding.

Table 3: The comparison analysis with some existing MPPT techniques

Methods	Complexity	Parameters sensed	Efficiency during partial shading	Tracking Speed	Remarks
GSA+RNN	Medium	Voltage and Current	High	High	accuracy under Partial shading condition
ANN	Medium	Voltage and Current	Medium	High	Reduced oscillations around MPP
I&C	Low	Voltage and Current	Poor	Medium	Not efficient under partial shading

6. Conclusion

In this paper, GSA based RNN algorithm was proposed for tracking the maximum power of PV system. Here, two inputs such as the panel

voltage and current are given to the input for GSA and the control signal is designed. The output of proposed method is the duty cycle 'Dc'. It defines the control signal to achieve the maximum power of the PV. The robustness and the dynamical performances of the proposed method are evaluated and described. Moreover, it is proven that the proposed controller is robust for the case of the desired input solar irradiance variations. The deviation rate of tracking error performances of the proposed method is compared. The simulation results show that the proposed controller overcomes the existing technique and achieves the maximum power and also, reduces the tracking error. Hence the proposed method achieves better performance, when compared with the other techniques.

References

1. S. A. O. da Silva, L. P. Sampaio and L. B. G. Campanhol, "Single-Phase Grid-Tied Photovoltaic System with Boost Converter and Active Filtering", In Proceedings of IEEE symposium on Industrial Electronics, 2502 (2014)
2. Abdelghani Harrag and Sabir Messalti, "Variable step size modified P&O MPPT algorithm using GA-based hybrid offline/online PID controller", Renewable and Sustainable Energy, 1247(2015)
3. Jubaer Ahmed and Zainal Salam, "An improved perturb and observe (P&O) maximum power point tracking (MPPT) algorithm for higher efficiency", Applied Energy, Vol.50, 97 (2015)
4. Lixia Sun, Zhengdandan and Fengling Han, "Study on MPPT Approach in Photovoltaic System Based on Fuzzy Control", In proceedings of IEEE conference on Industrial Electronics and Applications, 1259-1263, (June 2013)
5. Hegazy Rezk and Ali M. Eltamaly, "A comprehensive comparison of different MPPT techniques for photovoltaic systems", Solar Energy, Vol.112, 1, (2015)
6. Mahdi Rajabi Vincheh, Abbas Kargar and Gholamreza Arab Markadeh, "A Hybrid Control Method for Maximum Power Point Tracking (MPPT) in Photovoltaic Systems", Vol.39, No.6, 4715-4725, (2014)
7. F. Chekired, C. Larbes, D. Rekioua and F. Haddad, "Implementation of a MPPT fuzzy controller for photovoltaic systems on FPGA circuit", Energy Procedia, Vol.6, 541-549, (2011)
8. J. Solorzano and M.A. Egido, "Automatic fault diagnosis in PV systems with distributed MPPT", Energy Conversion and Management, Vol.76, 925-934, (2013)
9. A. Mellit, H. Rezzouk, A. Messai, B. Medjahed, "FPGA-based real time implementation of MPPT-controller for photovoltaic systems", Renewable Energy, Vol.36, 1652-1661, (2011)
10. Her-Terng Yau and Chen-Han Wu, "Comparison of Extremum-Seeking Control Techniques for Maximum Power Point Tracking in Photovoltaic Systems", Energies, Vol.4, 2180-2195, (2011)
11. J. Ghazanfari and M.M. Farsangi, "Maximum Power Point Tracking using Sliding Mode Control for Photovoltaic Array", Iranian Journal of Electrical & Electronic Engineering, Vol.9, No.3, pp.189-196, 2013
12. A. Messai, A. Mellit, A. Massi Pavan, A. Guessoum and H. Mekki, "FPGA-based implementation of a fuzzy controller (MPPT) for photovoltaic module", Energy Conversion and Management, Vol.52, 2695-2704, (2011).
13. G. Dileep and S.N. Singh, "Maximum power point tracking of solar photovoltaic system using modified perturbation and observation method", Renewable and Sustainable Energy, Vol.50, 109-129, (2015).
14. Angel A. Bayod-Rujula, Marta E. Haro-Larrode and Amaya Martinez-Gracia, "Sizing criteria of hybrid photovoltaic-wind systems with battery storage and self-consumption considering interaction with the grid", Solar Energy, Vol.98, pp.582-591, December 2013.
15. Esmat Rashedi, Hossein Nezamabadi-pour and Saeid Saryazdi, "GSA: A Gravitational Search Algorithm", Information Sciences, Vol.179, No.13, 2232-2248, (2009).
16. Serhat Dumana, Ugur Guvenc, Yusuf Sonmez and Nuran Yorukerenc, "Optimal power flow using gravitational search algorithm", Energy Conversion and Management, Vol.59, 86-95, (2012).
17. Chen, Chun-Jung, Tien-Chi Chen, and Jin-Chyz Ou, "Power system stabilizer using a new recurrent neural network for multi-machine", In proceedings of IEEE Conference on Power and Energy, 68-72, (2006).
18. Bensmail S., Rekioua D., Azzi H., "Study of hybrid photovoltaic/fuel cell system for stand-alone applications", International Journal of Hydrogen Energy, 40 (39), pp. 13820-13826. (2015)

Biography



S. Joshibha Ponmalar received her B.E. degree in Electrical and Electronics Engineering from Aalim Muhammed College of Engineering, Anna University, Tamil Nadu, India. She received her M.E. degree in High Voltage Engineering from College of Engineering, Guindy, Anna University, Chennai, India. She has 13 years of teaching experience. She is currently working as Assistant Professor in the department of Electrical and Electronics Engineering, Saveetha Engineering College, Thandalam, Chennai, India. Her research areas are renewable energy studies, Insulation studies, Power system transients, Insulation coordination of gas-insulated substations.



Valsalal Prasad graduated from Bharathiar University, Tami Nadu, Chennai, India, in 1990. She received the M.E. and Ph.D. degrees in electrical engineering from the College of Engineering Guindy, Anna University, in 1993 and 2006, respectively. Currently, she is an Professor in the Department of Electrical and Electronics Engineering, Anna University, Chennai. Her research areas are power system restoration, de-regulation in power systems, power system transients, insulation coordination of gas-insulated substations, surge arrester modeling, material study of the arrester for very-fast transient overvoltage applications and renewable energy studies.