

FUZZY-BASED COMMUTATION TORQUE RIPPLE MINIMIZATION AND POWER FACTOR CORRECTION USING MODIFIED SEPIC- PFC CONVERTER

P. Ebby Darney

Department of Electrical and Electronics Engineering, SCAD College of Engineering and Technology, Tirunelveli, INDIA, Email ID: pebbydarney@gmail.com

B. Dora Arul Selvi

Holy Cross Engineering College, Tuticorin, Tamil Nadu, India

Abstract: *The speed – torque features with smooth operation of permanent magnet Brushless DC Motor (PMBLDC) drives have received their recent attention in industries. The working functionality of diode bridge rectifier in PMBLDC motor drives are primarily being a cause for the reduction of power factor which in-turn makes depression in the quality of the power generated. To control the above problem, a single switch modified SEPIC-Single Ended Primary Inductor Converter with Power Factor Correction (PFC) can be used at the input end. The commutation torque ripples can be effectively managed using modified SEPIC converter. The safety of the drive is also efficiently addressed due to the production of buck-boost efficiency. The simulation analysis shows power quality and power factor in an improved manner challenging the state of art techniques.*

Keywords: *PMBLDC, PFC, SEPIC*

I.Introduction

The unbalanced charging and discharging of DC link capacitor in the PMBLDC motor [4,5] drive makes the input AC current waveform more distorted and makes higher peak current compared to the fundamental input current [1]. Due to the uneven voltage draw of diode bridge rectifier, power quality problems, total harmonics distortion, notching effect and crest factor (CF) are caused [2]. The overlapped commutation affects the efficiency of the drive [3].

In this paper, the modified SEPIC converter [9] as PFC AC-DC converter is used to run the PMBLDC motor drive. The PFC converter topology is used to shape the current waveform of the AC mains. A DC-DC converter is used to maintain the power factor [6-8]. We have also used PI speed control as well as DC link voltage control. The speed error signal is given to the PI speed controller and this gives the current signal which is equivalent to the torque signal. The proposed modified SEPIC-PFC converter topology

consists an uncontrolled diode bridge rectifier feed from single phase AC supply followed by the modified SEPIC converter, an output ripple filter and a three phase voltage source inverter feed voltage to the PMBLDC motor.

II.Operation of modified SEPIC Converter fed PMBLDC

The proposed topology of modified SEPIC-PFC converter fed PMBLDCM drive with PI speed control as well as DC link voltage control. Figure 1 gives the classical PFC SEPIC converter and Figure 2 gives the modified SEPIC-PFC converter based PMBLDC drive circuit topology. The PI control is used to drive the BLDC motor at constant speed. The Hall Effect sensors are used to sense the rotor position, from the position signals can find the speed, which is compared with the set speed which is compared with the set speed of the BLDC motor drive. The speed error signal is given to the PI speed controller and this gives the current signal which is equivalent to the torque signal.

This current signal is multiplied with the unit rectangular signal to produce the in phase current signal with respect to the back emf. This current signal is compared with the actual motor currents. These reference signals are compared with the triangular carrier signal to generate the PWM pulses which is given to the electronic commutators for turning on and off the devices. These control techniques only needs the rotor position for every 60 degree only. Therefore the control of electronic commutator is easy. The proposed modified SEPIC PFC converter topology, consist a uncontrolled diode bridge rectifier feed from single phase AC supply followed by the classical SEPIC converter, an output ripple filter and a three phase voltage source inverter feed voltage to the PMBLDC motor.

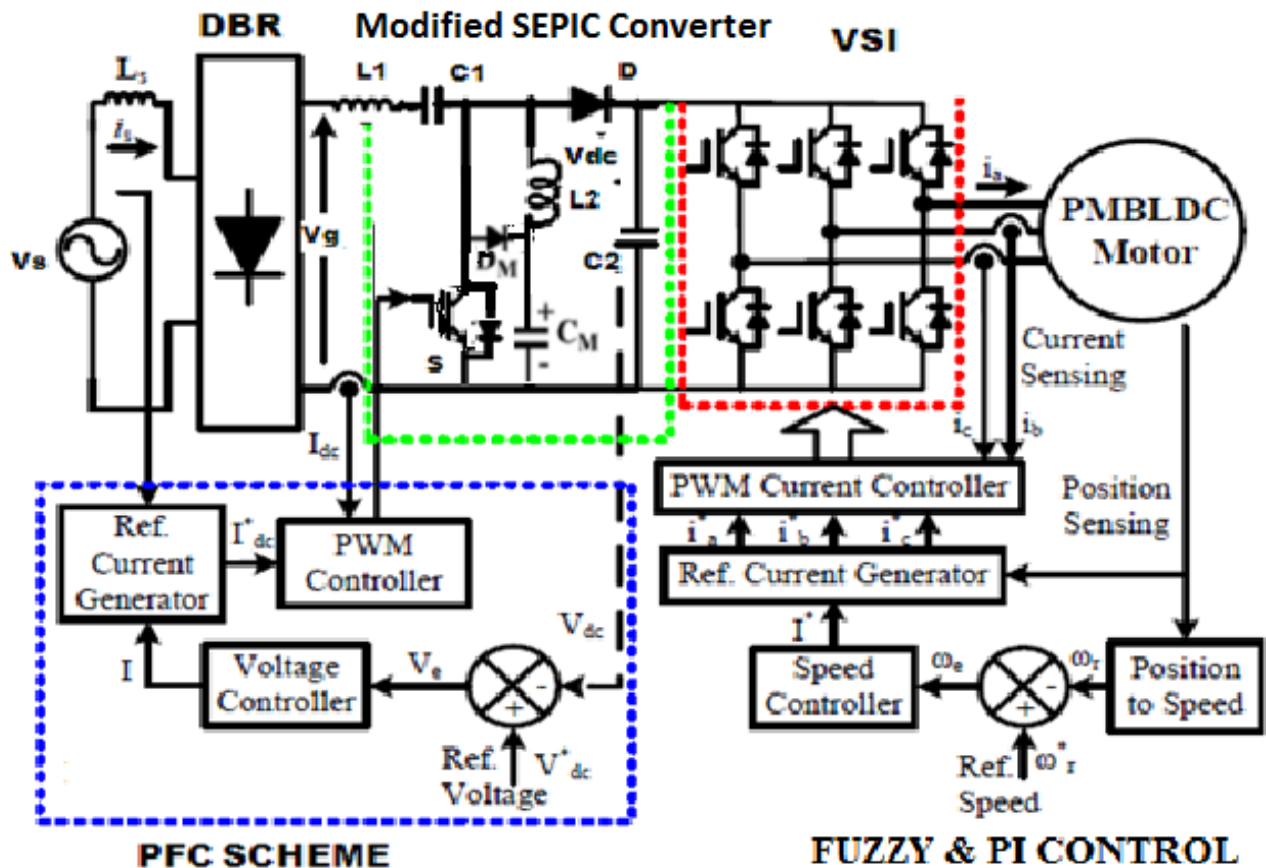

Figure I. Modified PFC SEPIC converter based PMBLDC drive circuit topology

The modified SEPIC converter gives a controlled and constant DC voltage from uncontrolled DC voltage from the diode bridge rectifier.

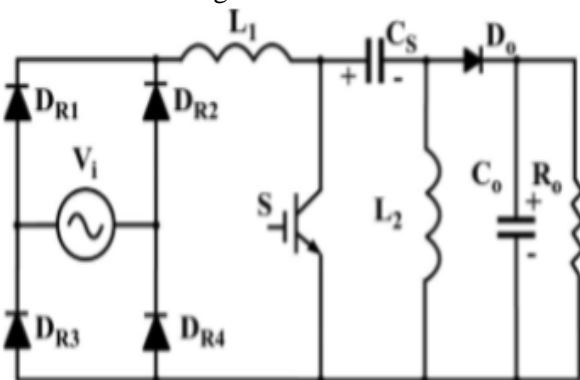

Figure II. Classical SEPIC Converter

The speed error signal is given to the PI speed controller and this gives the current signal which is equivalent to the torque signal. This current signal is multiplied with the unit rectangular signal to produce the in phase current signal with respect to the back emf. This current signal is compared with the actual motor currents. These reference signals are compared with the triangular carrier signal to generate the PWM pulses which is given to the electronic commutators for turning on and off the devices. These control techniques only need the rotor position for every 60 degree only. Therefore the control of electronic commutator is easy. The proposed modified SEPIC PFC converter topology consists of a diode bridge rectifier fed from a single phase AC supply followed by the classical SEPIC converter, an output

ripple filter and a three phase voltage source inverter feed voltage to the PMLDLC motor. The modified SEPIC converter gives a controlled and constant DC voltage from uncontrolled DC voltage from the diode bridge rectifier.

The modified SEPIC-PFC converter uses D_M as another diode and C_M as another capacitor in the classical SEPIC converter. Though the classical SEPIC-PFC converter works well, by using the modified SEPIC-PFC converter the switch voltage can be controlled to a greater extend. As like the classical SEPIC-PFC, the modified SEPIC-PFC converter gives low current ripple. The fuzzy-based speed controller is used to achieve the constant speed. The fuzzy controller reduces the maximum peak over shoot problem. So the motor efficiency also shows a increase when compared to the PI controller

III. Analysis of the Proposed System

The modified SEPIC-PFC converter consist of capacitors C_1 , C_2 and C_M . The analyses are divided into two modes, higher output voltage and the lower output voltage.

When the output voltage of the PFC converter can be lower than the input voltage, the duty cycle is less than 0.5. The capacitor voltage C_1 is lower than input voltage V_g .

In this mode the current through the inductor L1 is given in Equation (1).

$$\Delta IL_1 = \frac{V_0}{L_1} (0.5 - D)T \quad \dots (1)$$

and thus,

$$\frac{dIL_1}{dt} = (V_g + kV_0)/(1 - k^2)L_1 \quad \dots (2)$$

$$\frac{dIL_2}{dt} = -(V_0 + kV_g)/(1 - k^2)L_2 \quad \dots (3)$$

where k is the winding constant, D is the PWM duty cycle of the SEPIC converter and T is the total time of the PWM pulse.

From the above equations the inductor current is decreasing. Therefore the SEPIC converter output voltage will decrease. It is the buck mode. During the higher output voltage mode, the duty cycle is

comes to more than 0.5, it is the boost mode. Here the inductor currents IL_1 and IL_2 keep on increasin

$$\frac{dIL_1}{dt} = V_g/(1 + k)L_1 \quad \dots (4)$$

$$\frac{dIL_2}{dt} = V_g/(1 + k)L_2 \quad \dots (5)$$

The capacitor voltage C_1 is equal to the input DC voltage V_g . The change in inductor current can be expressed as,

$$\Delta IL_1 = \frac{V_0}{L_1} (D - D')T \quad \dots (6)$$

Due to this inductor current the output voltage becomes high. When analysing BLDC motor torque before and after using modified SEPIC converter, the switching time of the IGBT S1 to S6 (both turn on and off) is about 78ns and the diode reverse recovery time is about 19ns.

The DC link voltage is kept constant at 24 V with the input AC voltage of 24Vrms. The components of modified SEPIC-PFC converter are chosen on the basis of PQ constraints at AC mains and allowable ripple in DC-link voltage. The parameters in the controller can be tuned to get the desired PQ parameters and the values of controller gains. The performance analysis and evaluation is made based on different PQ parameters namely current total harmonic distortion (THDi) at input AC mains, distortion factor (DF), displacement power factor (DPF), power factor (PF), crest factor (CF), input AC current rms value (I_{srms}) and efficiency of the drive.

The Figure 3 shows the torque during starting. The BLDC motor achieves the rated torque at 0.01sec. After that the torque becomes constant, this makes the motor speed as constant.

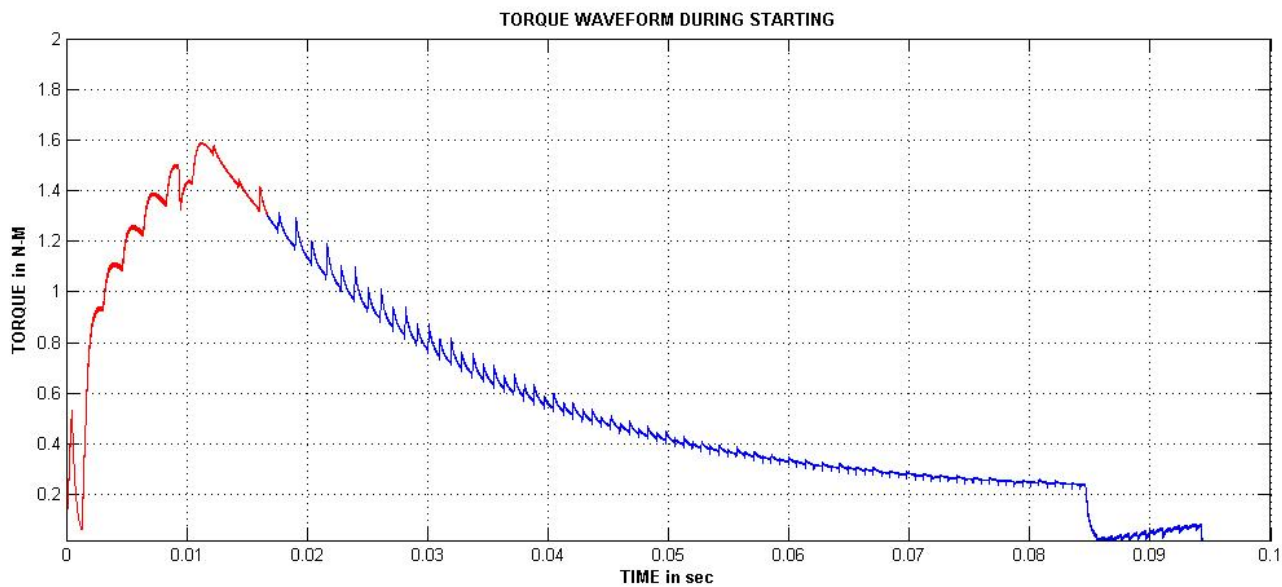
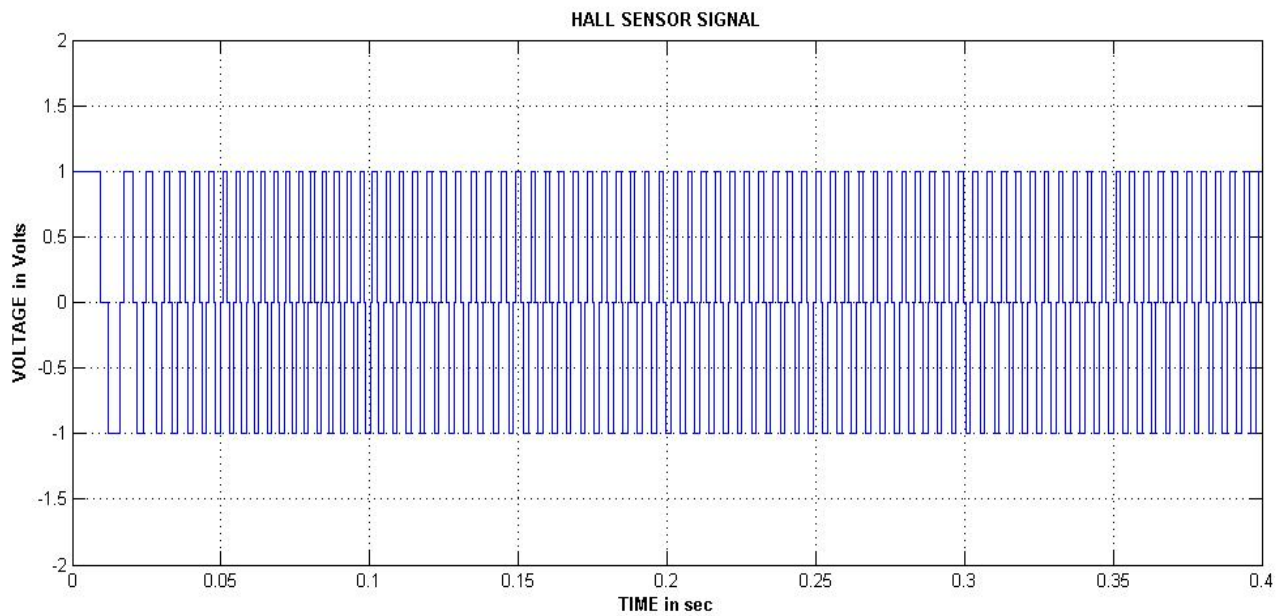
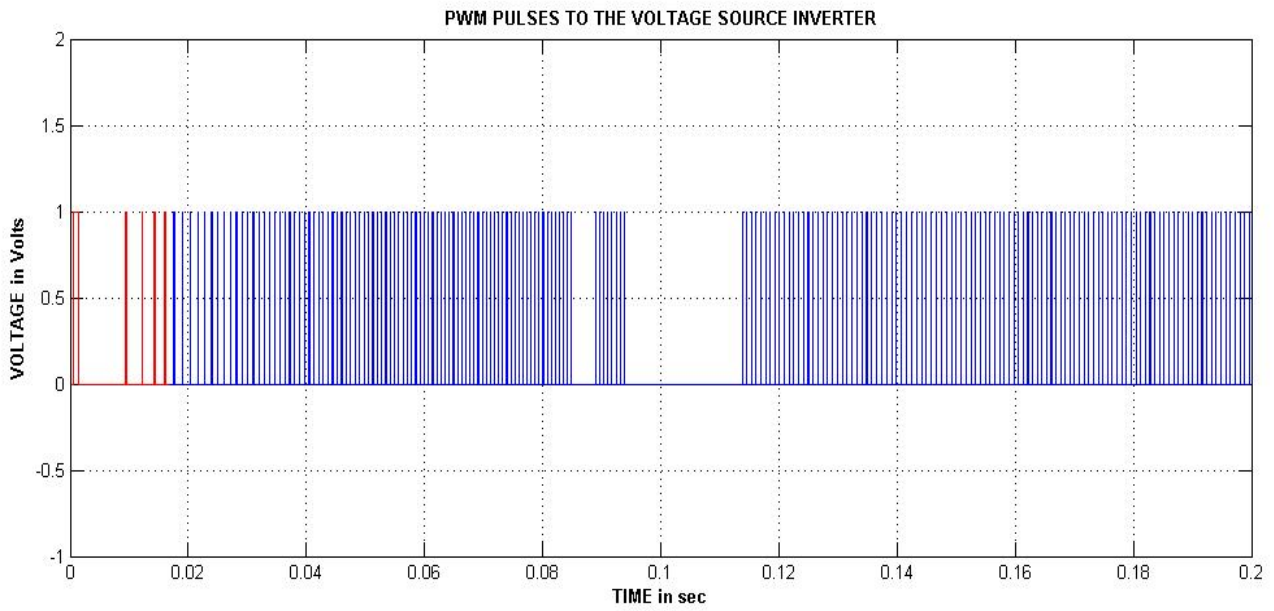

Figure. III. BLDC torque waveform at starting condition



(a)



(b)

Figure IV. BLDC motor (a) hall sensor signals at running condition and (b) PWM pulses to the Voltage source inverter

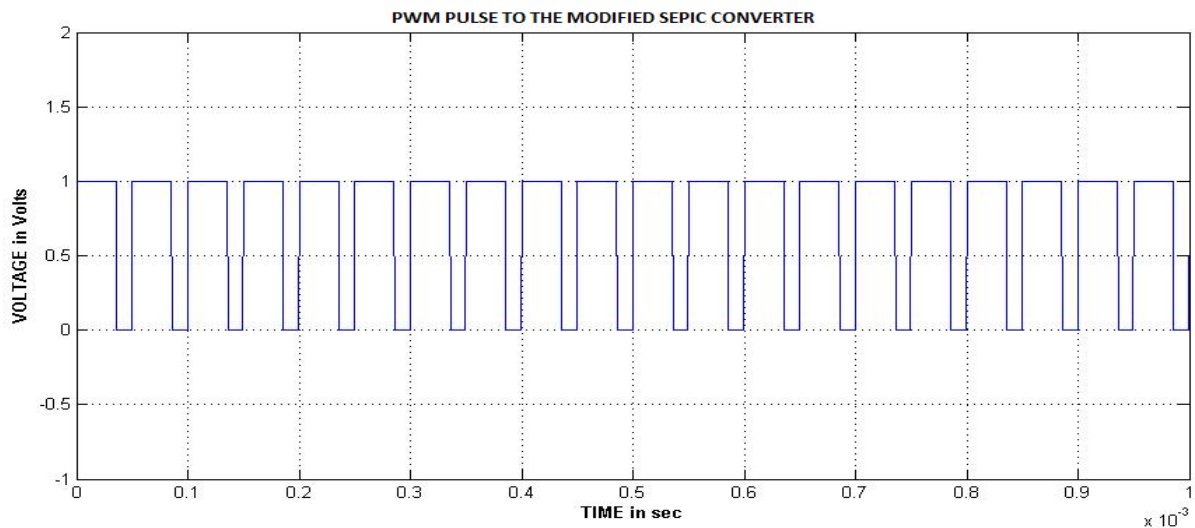

Figure V. PWM pulses to the updated SEPIC converter and inductor current waveform at running condition

Figure 5. Shows the PWM pulse to the SEPIC converter and this pulse will adjust the voltage to the inverter as constant. Due to this constant voltage

commutation torque ripples has reduced. Figure 6 gives the BLDC motor torque waveform without SEPIC converter and with SEPIC converter. The

BLDC motor achieves the rated speed at 0.05sec. The fuzzy logic speed controller achieves the constant speed, compared with the PI controller, the fuzzy logic controller achieves constant speed at

0.05sec thus by settling time has reduced. The fuzzy logic controller reduces the maximum peak over shoot problem. So that motor efficiency will slightly increases compared to the PI controller.

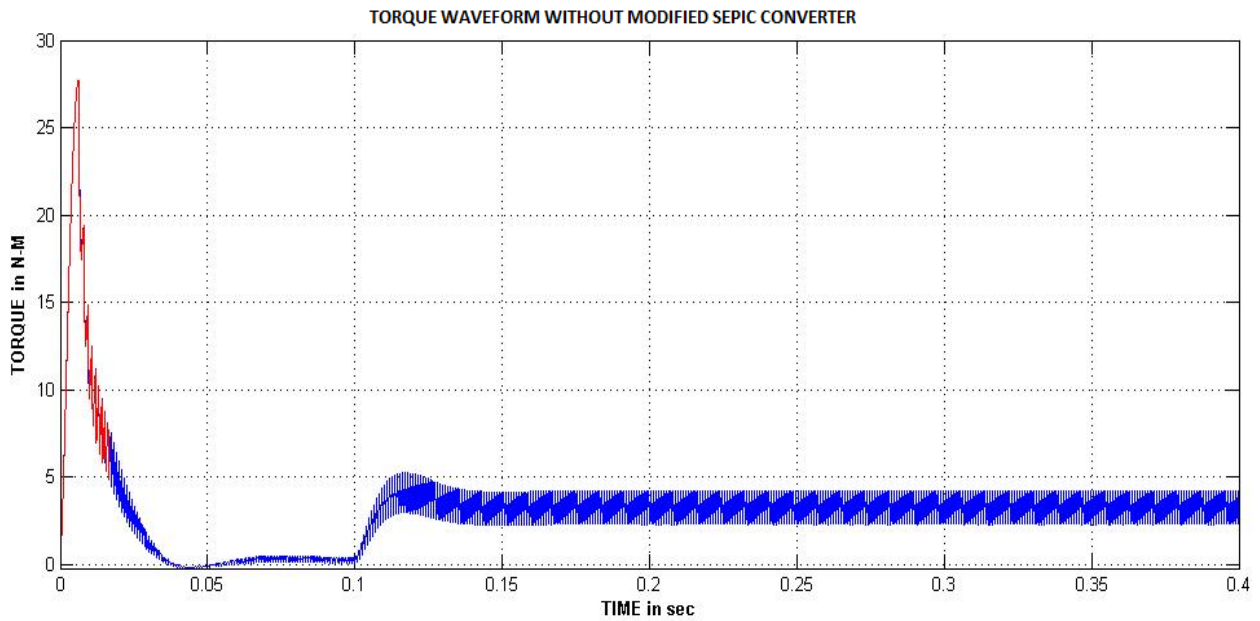

(a)

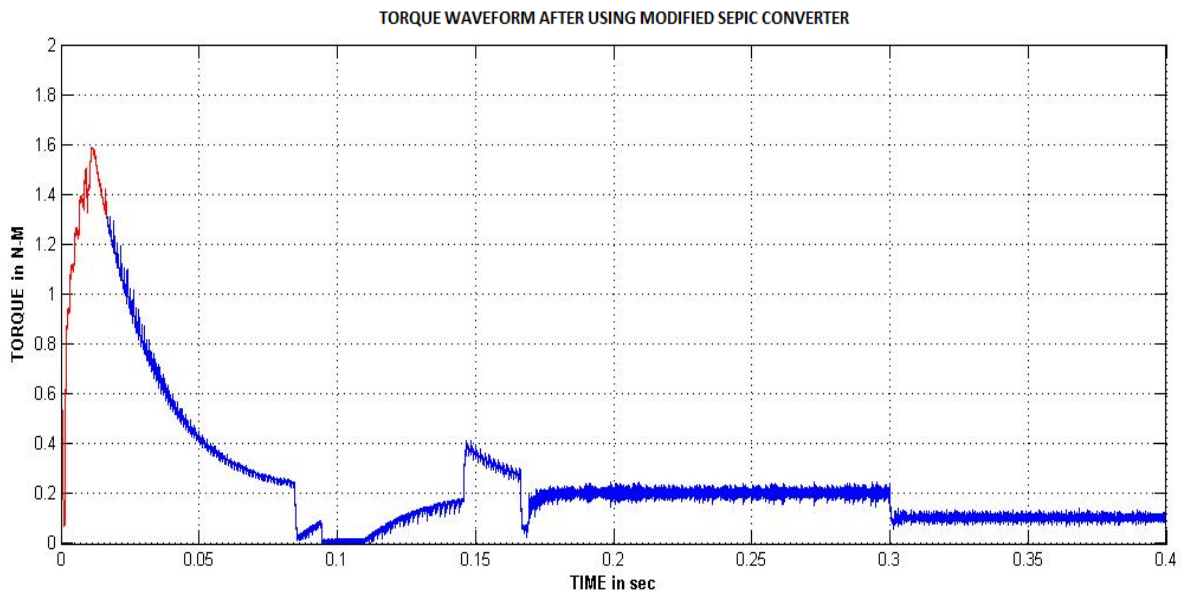

(b)

Figure VI. BLDC motor (a) torque waveform without SEPIC converter and (b) with SEPIC convertor

The SEPIC converter will reduce THD by providing constant voltage to the inverter. So the back emf is

constant thus by the current harmonics will decrease. Finally the source voltage and current comes to in phase. Due to this the power factor comes to unity.

IV. Conclusion

A SEPIC converter based power factor correction topology for a Permanent magnet Brushless DC motor drive has been proposed. This converter provides high power factor at the order of 0.9988 with wide range of the speed. Also the power quality performance are improved with closed loop speed control and smooth operation with less torque ripples. The AC source current THD is less than 5%, it obeys completely with international power quality norms. This SEPIC power factor converter topology has been found very suitable for the application at constant speed. The speed performance of the BLDC motor has compared by both PI and fuzzy logic controllers.

V. REFERENCES

1. Sanjeev Singh and Bhim Singh. *Power factor correction in PMLDC motor drive using single phase cuk converter. J. of Eng. Sci. and Tech.*, vol. 5, no. 4, 412 (2010).
2. Tingna Shi, YuntaoGuo, Peng Song, and Changliang Xia, *A New Approach of Minimizing Commutation Torque Ripple for Brushless DC Motor Based on DC-DC Converter, IEEE Trans. On Industrial Eng.*, vol.57, no.10, 3483 (2010)
3. J.R. Hendershort and T.J.E. Miller. *Design of brushless permanent-magnet motors, Oxford University Press, USA* (1994).
4. J. F. Gieras and M. Wing. *Permanent Magnet Motor Technology – Design and Application. CRC Press*(2002).
5. P. Pillay and R. Krishnan. *Modeling, simulation and analysis of a permanent magnet brushless dc motor drives, part II: the brushless dc motor drive. IEEE Trans. Ind. Appl.*, vol. 25, no. 2, 274 (1989).
6. T. Gopalarathnam and H.A. Toliyat. *A new topology for unipolar brushless dc motor drive with high power factor. IEEE Trans. Power on Electronics*, vol. 18, no.6, 1397(2003).
7. O. García, J.A. Cobos, R. Prieto, P. Alou and J. Uceda. *Single phase power factor correction: A survey. IEEE Trans. Power on Electronics*, vol. 18, no. 3, 749 (2003).
8. A. Barkley, D. Michaud, E. Santi, A. Monti and D. Patterson. *Single stage brushless DC motor drive with high input power factor for single phase applications. Proc. 37th IEEE Conf. on Power Electronics Specialists*, 1(2006).

9. Amrutha M.P. and Priya G. Das, *Modified SEPIC PFC Converter for Improved Power Factor and Low Harmonic Distortion* , *International Research Journal of Advanced Engineering and Science*, Volume 1, Issue 4, pp. 223-227 (2016).