

# MPPT Control Design of PV System Supplied SRM Using BAT Search Algorithm

A. S. Oshaba<sup>1,2</sup>, E. S. Ali<sup>2,3</sup> and S. M. Abd Elazim<sup>4</sup>

<sup>1</sup>Research Institute, Power Electronics and Energy Conversions, NRC Bldg., El-Tahrir St., Dokki, 12311-Giza, Egypt,  
Email: [oshaba68@hotmail.com](mailto:oshaba68@hotmail.com)

<sup>2</sup>Currently, Electrical Department, Faculty of Engineering, Jazan University, Jazan, Kingdom of Saudi Arabia,

<sup>3</sup>Electric Power and Machine Department, Faculty of Engineering, Zagazig University, Zagazig, Egypt,  
Email: [ehabsalimalisalama@yahoo.com](mailto:ehabsalimalisalama@yahoo.com)

<sup>4</sup>Electric Power and Machine Department, Faculty of Engineering, Zagazig University, Zagazig, Egypt,  
Email: [sahareldeep@yahoo.com](mailto:sahareldeep@yahoo.com)

**Abstract-** Maximum Power Point Tracking (MPPT) is used in Photovoltaic (PV) systems to maximize its output power, irrespective of the atmospheric conditions and electrical load characteristics. This paper suggests a new MPPT control design to PV system supplied Switched Reluctance Motor (SRM) based on PI controller. The developed PI controller is used to reach MPPT by monitoring the voltage and current of the PV array and adjusting the duty cycle of the DC/ DC converter. The design task of MPPT is formulated as an optimization problem which is solved by BAT search algorithm to seek for optimal parameters of PI controller. Simulation results have shown the validity of the suggested technique in delivering MPPT to SRM under atmospheric conditions. Moreover, the performance of the developed BAT algorithm is compared with Particle Swarm Optimization (PSO) for different disturbances to confirm its robustness.

**Key-Words:** BAT Search Algorithm; Particle Swarm Optimization; SRM; MPPT Control; PI Controller; Photovoltaic System.

## 1. Introduction

Photovoltaic (PV) systems have been used in remote applications as cost comes down such as wireless highway call boxes, and standalone power generation units. PV generation is gaining importance as a renewable source due to its advantages [1, 2], such as the absence of fuel cost, little maintenance, no noise, and wear due to the absence of moving parts.

The actual energy conversion efficiency of PV module is rather low and is affected by the weather conditions and output load. So, to overcome these problems and to get the maximum possible efficiency, the design of all the elements of the PV systems have to be optimized. The PV array has a highly nonlinear current-voltage characteristics varying with solar illumination and operating temperature [3, 4], that substantially affects the array output power. At particular solar illumination, there is unique operating point of PV array at which its output power is maximum. Therefore, for maximum power generation and extraction efficiency, it is necessary to match the PV generator to the load such that the equilibrium operating point coincides with the maximum power point of the PV array. The Maximum Power Point Tracking (MPPT) control is therefore critical for the success of the PV systems [5 -6]. In addition, the maximum power operating point varies with insolation level and temperature.

Therefore, the tracking control of the maximum power point is a complicated problem. To mitigate these problems, many tracking control strategies have been introduced such as perturb and observe [7], incremental conductance [8], parasitic capacitance [9], constant voltage [10] and reactive power control [11]. These strategies have some disadvantages such as high cost, difficulty, complexity and instability. In an effort to overcome aforementioned disadvantages, several researches have used artificial intelligence approach such as Fuzzy Logic Controller (FLC) [12-13] and Artificial Neural Network (ANN) [14- 18]. Although these methods are effective in dealing with the nonlinear characteristics of the current-voltage curves, they require huge computation. For example, FLC has to deal with fuzzification, rule base storage, inference mechanism, and defuzzification operations. For ANN, the large amount of data required for training are a major source of constraint. Furthermore, as the operating conditions of the PV system vary continuously. Clearly, a low cost processor cannot be employed in such a system.

An alternative approach is to employ Evolutionary Algorithm (EA) techniques. Due to its ability to handle nonlinear objective functions [19], EA is visualized to be very effective to deal with MPPT problem. Among the EA techniques, Genetic Algorithm (GA) [20], Particle Swarm Optimization (PSO) [21-22], and Bacteria Foraging (BF) [23-24] have attracted the attention in MPPT and controller design. However, these algorithms appear to be effective for the design problem, these algorithms pain from slow convergence in refined search stage, weak local search ability and algorithms may lead to possible entrapment in local minimum solutions. A relatively newer evolutionary computation algorithm, called BAT search algorithm has been presented by [25] and further established recently by [26-32]. It is a very simple and robust algorithm. In addition, it requires less control parameters to be tuned. Hence, it is suitable optimization tool for locating the maximum power point (MPP) regardless of atmospheric variations.

The main objective of this paper is to design PI controller via BAT algorithm to increase the tracking response of MPP for PV systems to power SRM with high efficiency. A comparison with PSO and open loop is carried out to ensure the robustness of the developed algorithm. Simulation results

have proved that the suggested controller gives better performance.

## 2. System under Study

The system under study consists of PV system acts as a voltage source for a connected SRM. The speed control loop is designed using ACO. The speed error signal is obtained by comparing between the reference speed and the actual speed. The output of the ACO controller is denoted as duty cycle. The schematic block diagram is shown in Fig. 1.

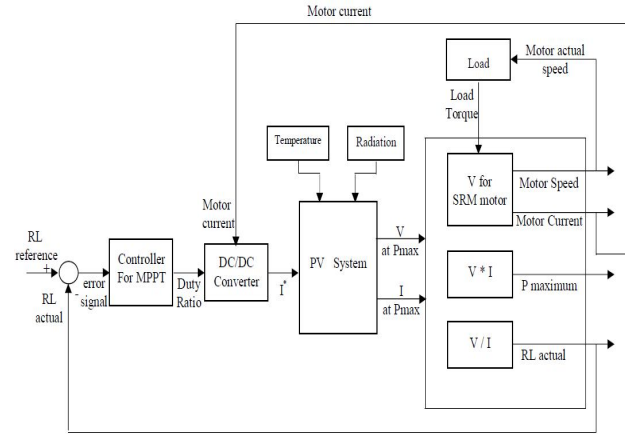

Fig. 1. The overall system for SRM control.

### 2.1 Construction of SRM

The construction of a 8/6 (8 stator poles, 6 rotor poles) poles SRM has doubly salient construction [33]. The construction is well shown in Fig 2. The windings of the SRM are simpler than those of other types of motors, and winding exists only on stator poles, and is simply wound on it with no winding on the rotor poles. The winding of opposite poles is connected in series or in parallel forming a number of phases, and exactly half the number of stator poles, and the excitation of a single phase excites two stator poles. The rotor has a simple laminated salient pole structure without winding. SRMs have the merit of reducing copper losses while its rotor is winding. Its stampings are made of silicon steel, especially in higher efficiency applications [33-35].

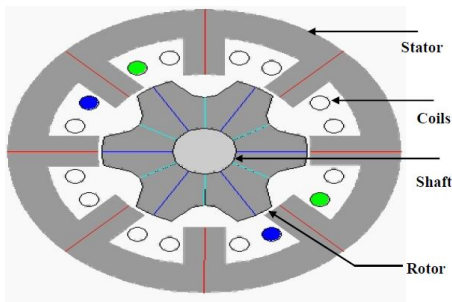

Fig. 2. The SRM 8/6 poles construction.

Torque is developed in SRMs due to the tendency of the magnetic circuit to adopt the configuration of minimum reluctance i.e. the rotor moves in line with the stator pole thus

maximizing the inductance of the excited coil. The magnetic behavior of the SRM is highly nonlinear. The static torque produced by one phase at any rotor position is calculated using the following equations [36-37].

$$Co \text{ energy} = W' = \int \psi(\theta, i) di \quad (1)$$

$$\text{Static torque} = T_{static} = dW' / d\theta \quad (2)$$

From equations (1) and (2) a similar static torque matrix can be estimated where current will give the row index and  $\theta$  will give the column index as in [36-37]. The value of developed torque can be calculated from the static torque look up table by using second order interpolation method by used them the current value and  $\theta$ .

The value of actual speed can be calculated from the following mechanical equations:

$$d\omega / dt = (T(\theta, i) - T_{mech}) / J \quad (3)$$

where, the speed error is obtained from the difference between the rotor speed and its reference. The value of rotor angular displacement  $\theta$  can be calculated from the following equation:

$$d\theta / dt = \omega \quad (4)$$

where  $\delta$  is the angle corresponding to the displacement of phase A in relation to another phase is given by:

$$\delta = 2\pi \left( \frac{1}{N_r} - \frac{1}{N_s} \right) \quad (5)$$

where  $N_r$  and  $N_s$  are the number of rotor and stator poles respectively. Also, the positive period of phase is determined by the following equation:

$$\text{duty period} = 2\pi \left( \frac{1}{qN_r} \right) C_r \quad (6)$$

where  $q$  is number of phases and  $C_r$  is the commutation ratio.

$C_r$  can be calculated by the following equation.

$$C_r = 2\pi \left( \frac{1}{\beta_r} - \frac{1}{\beta_s} \right) \quad (7)$$

where  $\beta_s$  and  $\beta_r$  are the stator and rotor pole arc respectively.

Duration of negative current pulses is depended on the stored energy in phase winding. On running, the algorithm is corrected by PI controller. This method is suitably with special range for turn on angle. The parameters of SRM are shown in appendix.

### 2.2 Photovoltaic System

Solar cell mathematical modeling is an important step in the analysis and design of PV control systems. The PV mathematical model can be obtained by applying the fundamental physical laws governing the nature of the components making the system [38].

To overcome the variations of illumination, temperature, and load resistance, voltage controller is required to track the new modified reference voltage whenever load resistance,

illumination and temperature variation occurs. I-V characteristics of solar cell are given by the following equations [39-40]:

$$I_c = I_{ph} - I_o \left\{ e^{\left[ \frac{q_o}{AKT} (V_c + I_c R_s) \right]} - 1 \right\} \quad (8)$$

$$V_c = \frac{AKT}{q_o} \ln \left( \frac{I_{ph} + I_o - I_c}{I_o} \right) - I_c R_s \quad (9)$$

$$I = I_{ph} - I_o \left\{ e^{\left[ \frac{q_o}{n_s AKT} (V + n_s I R_s) \right]} - 1 \right\} \quad (10)$$

$$V = \frac{n_s AKT}{q_o} \ln \left( \frac{I_{ph} + I_o - I}{I_o} \right) - n_s I R_s \quad (11)$$

where;

$$I_{ph} = \frac{G}{1000} [I_{sc} + k_i (T - T_r)] \quad (12)$$

$$I_o = I_{or} \left( \frac{T}{T_r} \right)^3 e^{\left[ \frac{q_o E_g}{AK} \left( \frac{1}{T_r} - \frac{1}{T} \right) \right]} \quad (13)$$

The module output power can be determined simply from  $P = V.I$

where;

- $I$  and  $V$  : Module output current and voltage,
- $I_c$  and  $V_c$  : Cell output current and voltage,
- $I_{ph}$  and  $V_{ph}$  : The light generation current and voltage,
- $I_s$  : Cell reverse saturation current,
- $I_{sc}$  : The short circuit current,
- $I_o$  : The reverse saturation current,
- $R_s$  : The module series resistance,
- $T$  : Cell temperature,
- $K$  : Boltzmann's constant,
- $q_o$  : Electronic charge,
- $KT$  : (0.0017 A/°C) short circuit current temperature coefficient,
- $G$  : Solar illumination in  $W/m^2$ ,
- $E_g$  : Band gap energy for silicon,
- $A$  : Ideality factor,
- $T_r$  : Reference temperature,
- $I_{or}$  : Cell rating saturation current at  $T_r$ ,
- $n_s$  : Series connected solar cells,
- $k_i$  : Cell temperature coefficient.

Thus, if the module parameters such as module series resistance ( $R_s$ ), reverse saturation current ( $I_o$ ), and ideality factor ( $A$ ) are known, the I-V characteristics of the PV module can be simulated by using equations (12 and 13). PV system is used in this paper to power SRM. The parameters of PV system are given in appendix.

### 2.3 DC-DC Converter

The choice DC-DC converter technology has a significant impact on both efficiency and effectiveness. Many converters have been used and tested; buck converter is a step down converter, while boost converter is a step up converter [41-43]. In this paper, a hybrid (buck and boost) DC/DC converter is used. The equations for this converter type in continuous conduction mode are [44]:

$$V_B = \frac{-k}{1-k} V_{ph} \quad (15)$$

$$I_B = \frac{k-1}{k} I_{ph} \quad (16)$$

where  $k$  is the duty cycle of the Pulse Width Modulation (PWM) switching signal.  $V_B$  and  $I_B$  are the output converter voltage and current respectively. The Matlab/Simulink of PV system can be simulated as shown in Fig. 3.

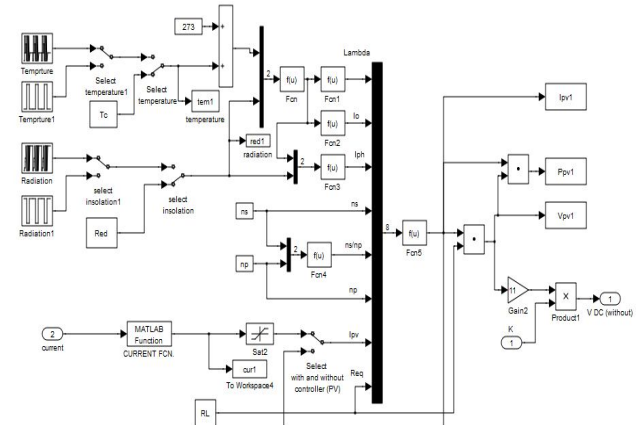

Fig. 3. Matlab/Simulink for PV system.

### 3. Objective Function

A performance index can be defined by the Integral of Time multiply Absolute Error (ITAE). Accordingly, the objective function  $J_t$  is set to be:

$$J_t = \int_0^{\infty} t(|e|) dt \quad (17)$$

where  $e = R_{Lreference} - R_{Lactual}$  and  $R_{Lactual} = V / I$

Based on this objective function  $J_t$  optimization problem can be stated as: Minimize  $J_t$  subjected to:

$$K_p^{minimum} \leq K_p \leq K_p^{maximum}$$

$$K_i^{minimum} \leq K_i \leq K_i^{maximum} \quad (18)$$

Normal limits of the optimized parameters are [0.01- 20]. This paper converges on optimal tuning of PI controller for MPPT of PV system supplied SRM via BAT search algorithm.

#### 4. Optimization Algorithms

##### 4.1 Overview of BAT Search Algorithm

BAT search algorithm is an optimization algorithm inspired by the echolocation behavior of natural bats in locating their foods. It is developed by Yang [25-28] and is used for solving various optimization problems. Each virtual bat in the initial population employs a homologous manner by performing echolocation way for updating its position. Bat echolocation is a perceptual system in which a series of loud ultrasound waves are released to create echoes. These waves are returned with delays and various sound levels which qualify bats to spot a specific prey. Some rules are introduced to extend the structure of BAT algorithm and use the echolocation characteristics of bats [29-30].

- Each bat utilizes echolocation characteristics to classify between prey and barrier.
- Each bat flies randomly with velocity  $v_i$  at position  $x_i$  with a fixed frequency  $f_{min}$ , varying wavelength  $\lambda$  and loudness  $L_0$  to seek for prey. It regulates the frequency of its released pulse and adjust the rate of pulse release  $r$  in the range of [0, 1], relying on the closeness of its aim.
- Frequency, loudness and pulse released rate of each bat are varied.
- The loudness  $L_i^{iter}$  changes from a large value  $L_0$  to a minimum constant value  $L_{min}$ .

The position  $x_i$  and velocity  $v_i$  of each bat should be defined and updated during the optimization task. The new solutions  $x_i^t$  and velocities  $v_i^t$  at time step  $t$  are performed by the following equations [31-32]:

$$f_i = f_{min} + (f_{max} - f_{min})\alpha \quad (19)$$

$$v_i^t = v_i^{t-1} + (x_i^t - x^*)f_i \quad (20)$$

$$x_i^t = x_i^{t-1} + v_i^t \quad (21)$$

where  $\alpha$  in the range of [0, 1] is a random vector drawn from a uniform distribution.  $x^*$  is the current global best location, which is achieved after comparing all the locations among all the  $n$  bats. As the product  $\lambda_i f_i$  is the velocity increment, one can consider either  $f_i$  (or  $\lambda_i$ ) to set the velocity change while fixing the other factor. For implementation, every bat is randomly assigned a frequency

which is drawn uniformly from  $(f_{min}, f_{max})$ . For the local search, once a solution is chosen among the current best solutions, a new solution for each bat is generated using random walk.

$$x_{new} = x_{old} + \varepsilon L^t \quad (22)$$

Where,  $\varepsilon \in [-1, 1]$  is a random number, while  $L^t$  is the average loudness of all bats at this time step. As the loudness usually reduces once a bat has found its prey, while the rate of pulse emission increases, the loudness can be elected as any value of convenience. Assuming  $L_{min} = 0$  means that a bat has just found the prey and temporarily stop emitting sound, one has:

$$L_i^{t+1} = \beta L_i^t, \quad r_i^{t+1} = r_i^0 [1 - \exp(-\gamma t)] \quad (23)$$

Where,  $\beta$  is constant in the range of [0, 1] and  $\gamma$  is positive constant. As time reach infinity, the loudness tend to be zero, and  $\gamma_i^t$  equal to  $\gamma_i^0$ . The flow chart of BAT algorithm is shown in Fig. 4, and the parameters of BAT are given in appendix.

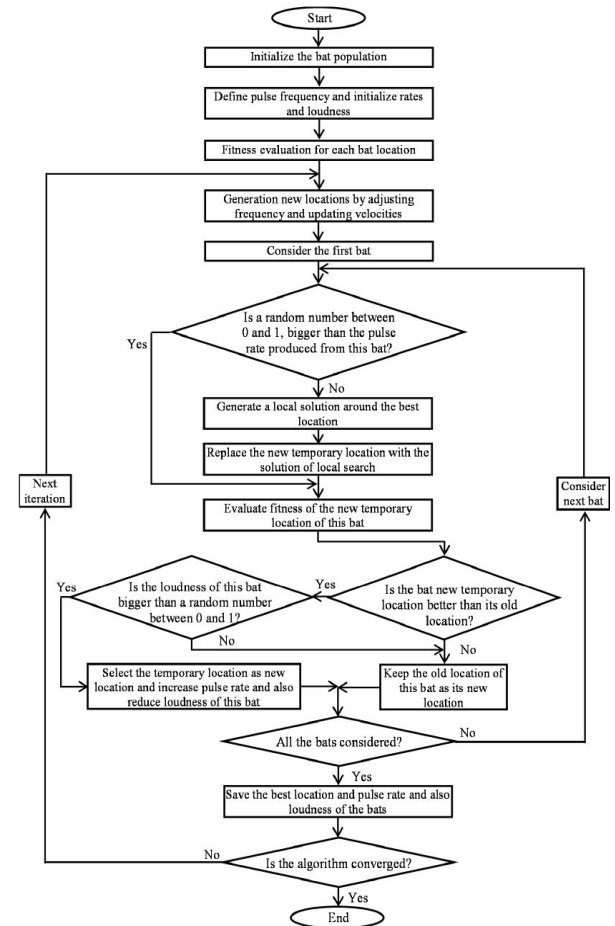

Fig. 4. Flow chart of BAT search algorithm.

#### 4.2 Particle Swarm Optimization Algorithm

Particle Swarm Optimization (PSO) is a form of evolutionary computation technique developed by Kennedy and Eberhart [45]. It is inspired by the behavior of a flock of birds in searching for food. One major difference between particle swarm and traditional evolutionary computation methods is that particles' velocities are adjusted, while evolutionary individuals' positions are acted upon; it is as if the "fate" is altered rather than the "state" of the particle swarm individuals [46-48]. Moreover, PSO is a metaheuristic as it makes few or no assumptions about the problem being optimized and can search very large spaces of candidate solutions. However, PSO do not guarantee an optimal solution is ever found. Also, PSO suffers from the partial optimism, which causes the less exact at the regulation of its velocity and the position. Moreover, the algorithm cannot work out the problems of scattering and optimization [49-50]. The flow chart of PSO is given in Fig. 5.

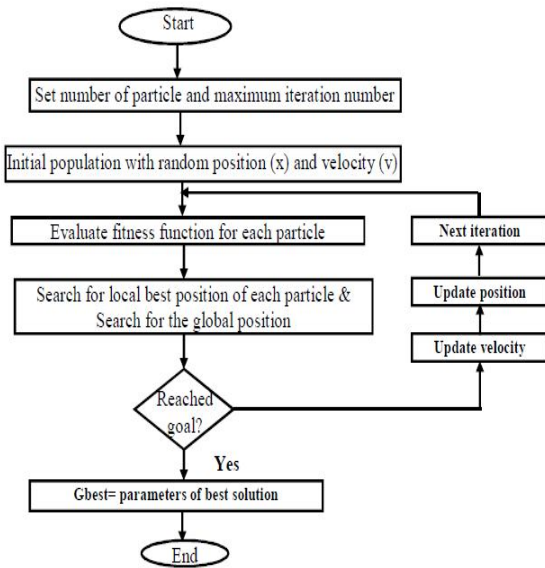

Fig. 5. Flow chart of PSO algorithm.

#### 5. Results and Discussion

In this section, several comparative cases are examined to show the effectiveness of the developed BAT algorithm compared with PSO under variations of ambient temperature, radiation and load torque. The designed parameters of PI controller with the proposed BAT, and PSO are given in Table 1. The proposed BAT methodology and PSO are programmed in MATLAB 7.1 and run on an Intel(R) Core(TM) I5 CPU 2.53 GHz and 4.00 GB of RAM.

Table .1. Parameters of PI controller for various algorithms.

	$K_P$	$K_i$
PSO	0.0032	8.527
BAT	0.0046	8.936

#### 5.1 Response under change of radiation

In this case, the system responses under variation of PV system radiation are illustrated. Fig. 6 shows the variation of the PV system radiation as an input disturbance while temperature is constant at 27°C. Moreover, the variations of PV system response based on different algorithms are shown in Figs. 7-8. It is clear from these Figs.; that the proposed BAT based controller improves the MPPT control effectively w.r.t estimated value. Furthermore, the value of power per cell based on BAT algorithm is greater than twice its value at open loop (without MPPT controller). Also, an increment of 0.1 watt/cell is achieved based on BAT algorithm over its value based on PSO. Hence, BAT algorithm is better than PSO in achieving MPP. In addition, PI controller based on BAT enhances the performance characteristics of PV system and reduces the number of PV cells compared with that based on PSO technique.

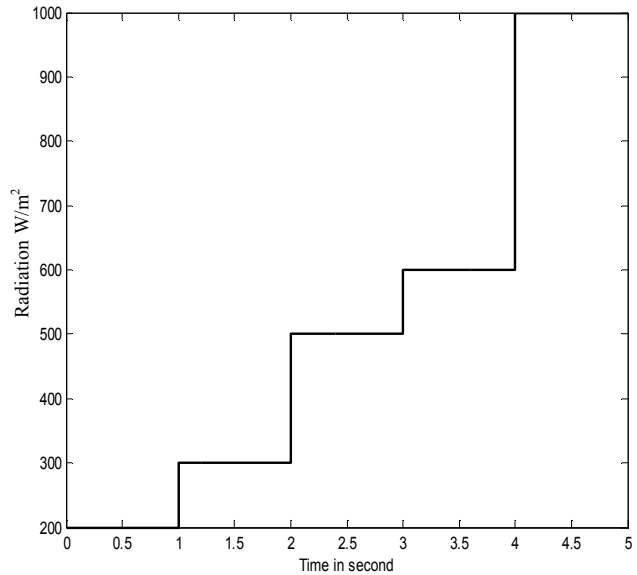

Fig. 6. Change of radiation.

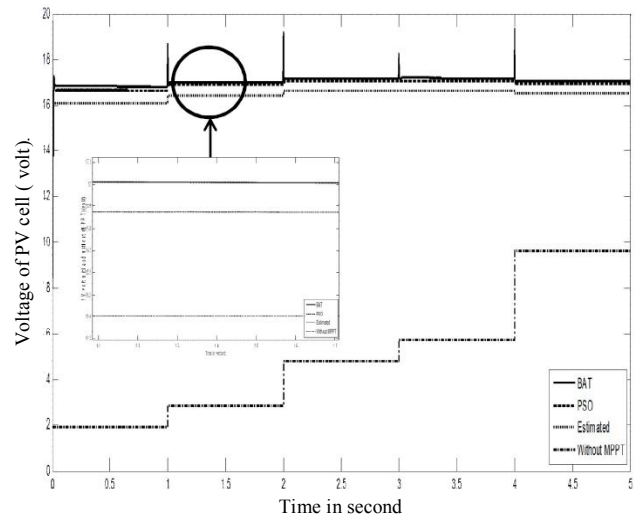

Fig. 7. Change of PV volt for different radiations and controllers.

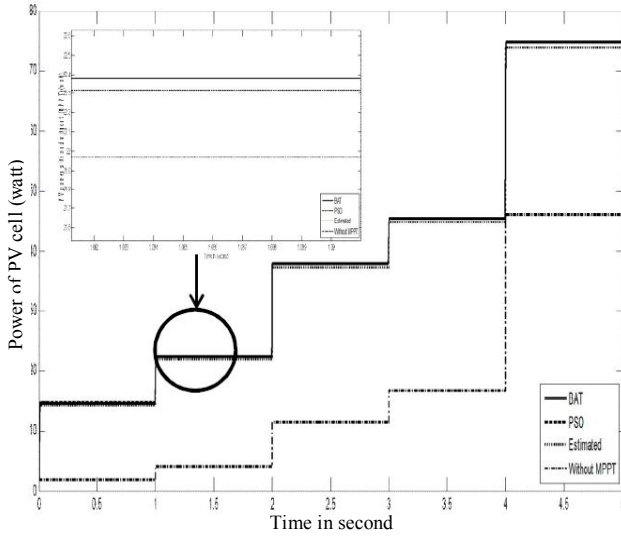

Fig. 8. Change of PV power for different radiations and controllers.

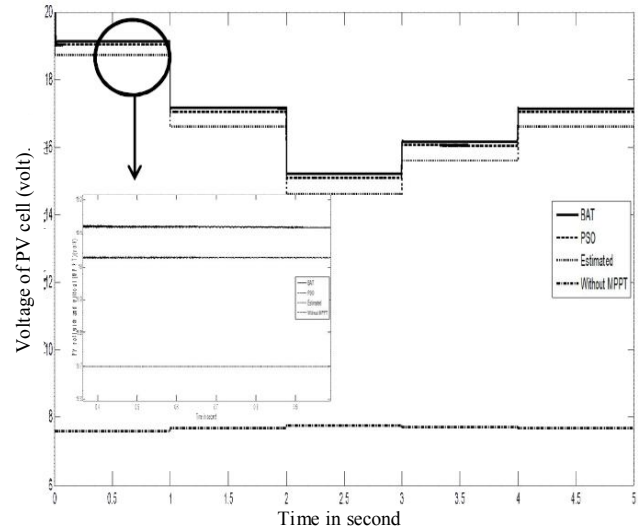

Fig. 10. Change of PV volt for different temperatures and controllers.

### 5.2 Response under change of temperature

The system responses under variation of PV system temperature are discussed in this case. Fig. 9 shows the change of the PV system temperature as an input disturbance while radiation is constant at  $800 \text{ W/m}^2$ . Also, the PV system responses based on different algorithms are given in Figs. 10-11. It is clear from these Figs., that the suggested technique based controller enhances the tracking efficiency of MPP. Moreover, the developed method outperforms and outlasts PSO in designing MPPT controller. Also, the value of power/cell based on BAT algorithm is greater than PSO and open loop case. As a result, the number of solar cells and cost are largely reduced. Hence, PI based BAT greatly improves the performance characteristics of MPPT over other algorithms.

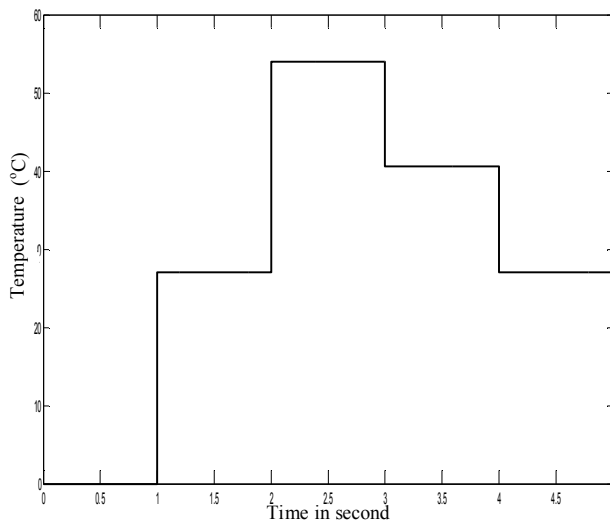

Fig. 9. Change of temperature.

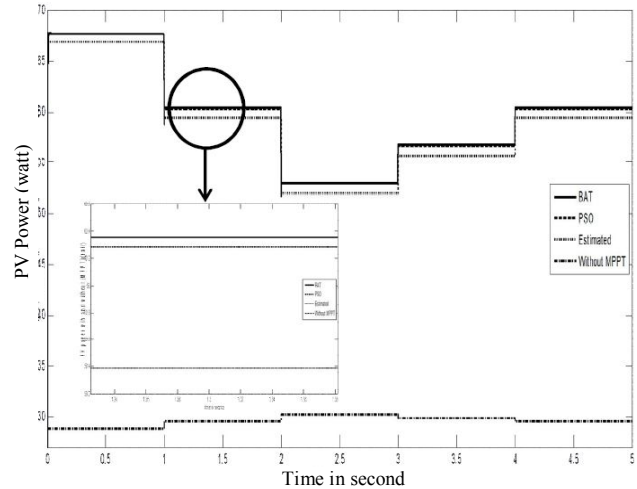

Fig. 11. Change of PV power for different temperatures and controllers.

### 5.3 Response under change of radiation and temperature

In this case, the system responses under variation of PV system radiation and temperature are examined. The variations of the PV system radiation and temperature as input disturbances are shown in Fig. 12. Moreover, the changes of PV system response based on different algorithms are presented in Figs. 13-14. It is shown that the developed BAT based controller increases power of PV system compared with PSO and consequently reduces the number of solar cells and cost.

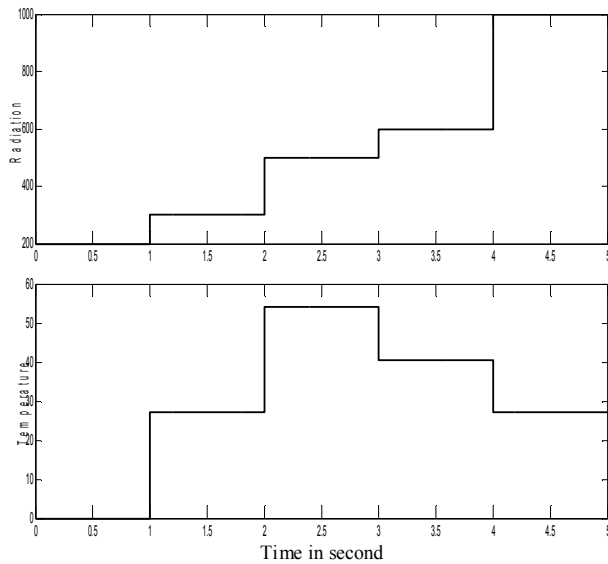

Fig. 12. Change of radiation and temperature.

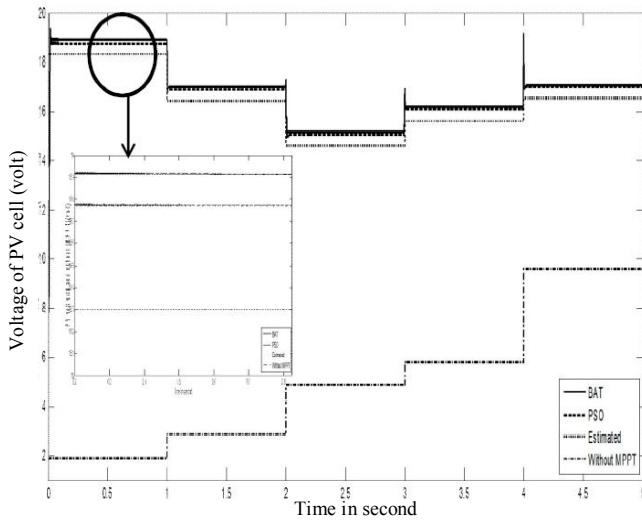

Fig. 13. Change of PV voltage for various controllers.

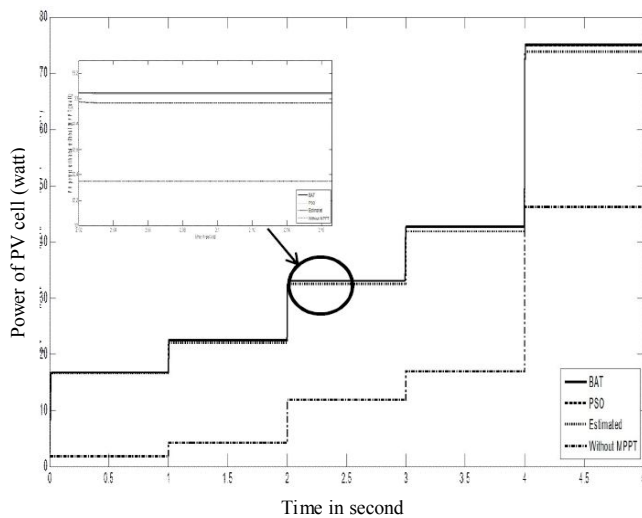

Fig. 14. Change of PV power for various controllers.

#### 5.4 Response under step of load torque, radiation and temperature

Fig. 15. shows the step change of load torque of SRM, radiation and temperature of PV system. The responses of PV system are given in Figs. 16-17. It is shown that the developed BAT based controller increases the power of PV system compared with PSO and consequently reduces the number of solar cells and cost. In addition, the designed controller is robust in its operation and gives a superb performance compared with PSO tuning PI controller.

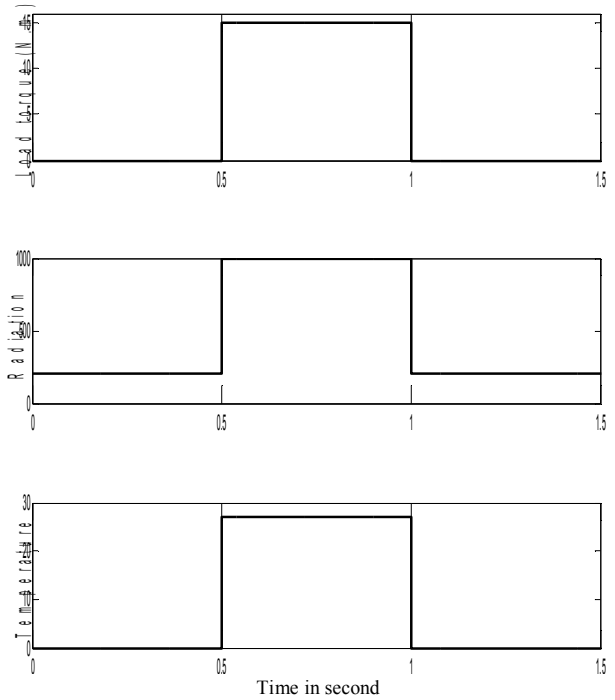

Fig. 15. Step change in load torque and PV system parameters.

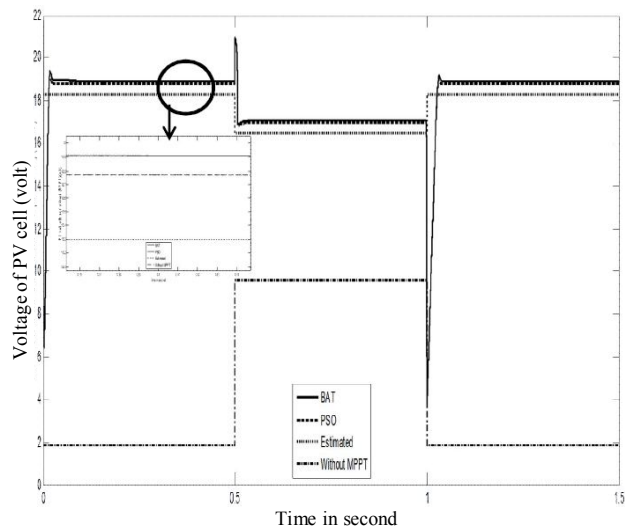

Fig. 16. Change of PV volt for step change of variables.

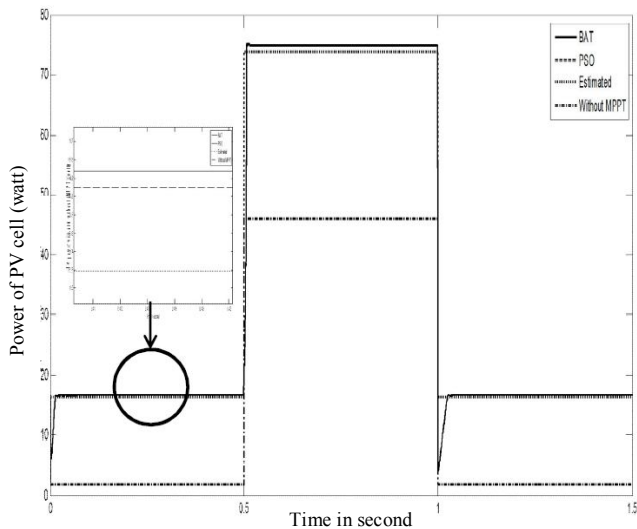

Fig. 17. Change of PV power for step change of variables.

**5.5 Response under change of load torque, radiation and temperature:**

Fig. 18. shows the change of load torque, radiation and temperature. Figs. 19-20. show the responses of PV system with different controllers. It is clear from this Fig, that the suggested controller is efficient in enhancing MPPT of PV system compared with PSO. Hence, the potential and superiority of the developed controller over the PSO is demonstrated.

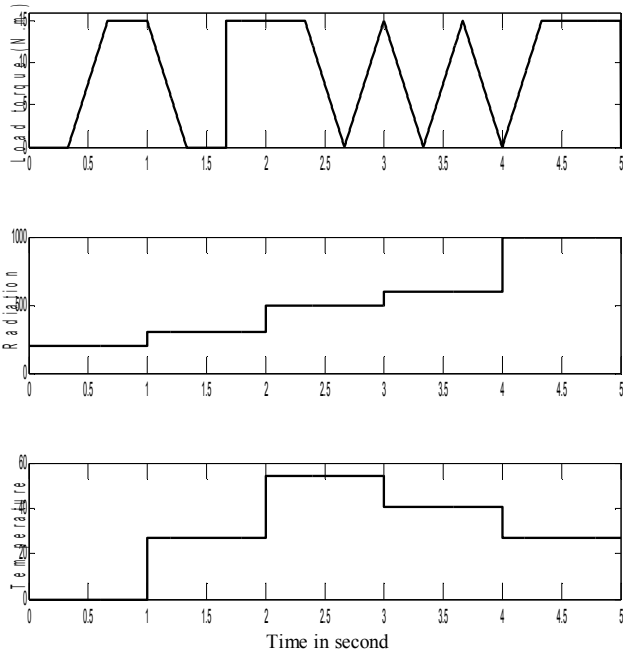

Fig. 18. Change in load torque and PV system parameters.

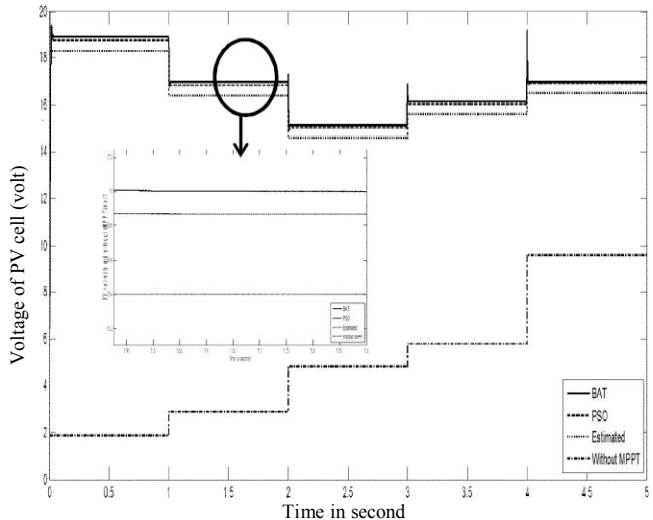

Fig. 19. Change of PV volt for variable load torque and PV system parameters.

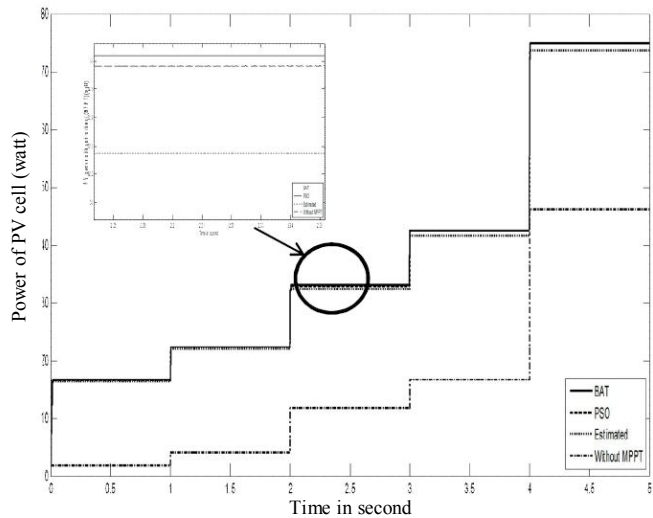

Fig. 20. Change of PV watt for variable load torque and PV system parameters.

**6. Conclusions**

In this paper, a novel method for MPPT of PV system supplied SRM (8/6 poles) is proposed via BAT search algorithm. The controlled system comprises of a PV generator that feeds a SRM through buck boost DC/DC converter. The design problem of the proposed controller is formulated as an optimization process and BAT is employed to seek for optimal parameters of PI controller. By minimizing the time domain objective function, in which the difference between the reference load resistance and actual one are involved; MPPT of PV system powered SRM is improved. Simulation results emphasis that the designed BAT based PI controller is robust in its operation and gives a superb performance for the change in load torque, radiation, and temperature compared with PSO. Besides the simple



architecture of the proposed controller, it has the potentiality of implementation in real time environment.

## Appendix

- a) SRM parameters:  $N_s=8$ ,  $N_r=6$ , Rating speed =13700 r.p.m,  $C_r=0.8$ ,  $q=4$ , Phase resistance of stator=17 ohm, Phase inductance of aligned position=0.605 H, Phase inductance of unaligned position=0.1555 H, Step angle=15°.
- b) PV parameters:  $A = 1.2153$ ;  $E_g = 1.11$ ;  $I_{or} = 2.35e-8$ ;  $I_{sc}=4.8$ ;  $T_r=300$ ;  $K= 1.38e-23$ ;  $n_s=36$ ;  $q_o=1.6e-19$ ;  $k_i=0.0021$ .
- c) The parameters of BAT search algorithm are as follows: Max generation=100; Population size=50;  $\beta=\gamma=0.9$ ,  $L_{min}=0$ ;  $L_0=1$ ,  $f_{min}=0$ ;  $f_{max}=100$ .
- d) PSO parameters: Max generation=100; No. of Population in swarm =50;  $C_1=C_2=2$ ;  $\omega=0.9$ .

## References

- [1] Z. Sen, "Solar Energy Fundamentals and Modeling Techniques", 2008, Springer.
- [2] S. C. W. Krauter, "Solar Electric Power Generation-Photovoltaic Energy Systems", Springer-Verlag Berlin Heidelberg 2006.
- [3] A. V. da Rosa, "Fundamentals of Renewable Energy Processes", Elsevier Press, 2005.
- [4] P. Würfel, "Physics of Solar Cells from Principles to New Concepts", 2005, Wiley.
- [5] M. Veerachary, T. Seniyu and K. Uezato, "Maximum Power Point Tracking Control of IDB Converter Supplied PV System", IEE Proc. Electronic Power Applications, Vol. 148. No. 6, November 2001, pp. 494-502.
- [6] S. Armstrong and W. Hurley, "Self Regulating Maximum Power Point Tracking for Solar Energy Systems", 39<sup>th</sup> Int. Universities Power Engineering Conference, UPEC 2004, Bristol, UK, pp. 604-609.
- [7] L. Piegari, and R. Rizzo, "Adaptive Perturb and Observe Algorithm for Photovoltaic Maximum Power Point Tracking", IET Renewable Power Generation, 2010, Vol. 4, No. 4, pp. 317-328.
- [8] A. Brambilla, M. Gambarara, A. Garutti and F. Ronchi, "New Approach to Photovoltaic Arrays Maximum Power Point Tracking", 30<sup>th</sup> Annual IEEE Power Electronics Specialists Conference 1999 (PESC 99), Vol. 2, pp. 632 - 637.
- [9] D. P. Hohm, and M. E. Ropp, "Comparative Study Of Maximum Power Point Tracking Algorithm Using an Experimental Programmable, Maximum Power Point Tracking Test Bed", In Proceedings 28<sup>th</sup> IEEE Photovoltaic Specialist Conference, 2000. pp. 1699-1702.
- [10] W. Swiegers, and J. Enslin, "An Integrated Maximum Power Point Tracker for Photovoltaic Panels", In Proceedings IEEE International Symposium on Industrial Electronics, Vol. 1, 1998, pp. 40 - 44.
- [11] M. Oshiro, K. Tanaka, T. Senjyu, S. Toma, Y. Atsushi, A. Saber, T. Funabashi, and C. Kim, "Optimal Voltage Control In Distribution Systems Using PV Generators", Int. J. of Electrical Power and Energy Systems, Vol. 33, No. 3, March 2011, pp. 485-492.
- [12] J. Hui and X. Sun, "MPPT Strategy of PV System Based on Adaptive Fuzzy PID Algorithm", Int. Conference on Life System Modeling and Simulation, LSMS 2010, and Int. Conference on Intelligent Computing for Sustainable Energy and Environment, ICSEE 2010, Vol. 97, 2010, pp. 220-228.
- [13] M. Ouada, M. Meridjet, M. Saoud, and N. Talbi, "Increase Efficiency Of Photovoltaic Pumping System Based BLDC Motor Using Fuzzy Logic MPPT Control", WSEAS Transactions on Power Systems, Vol. 8, No. 3, July 2013, pp. 104-113.
- [14] A. Al-Amoudi and L. Zhang, "Application of Radial Basis Function Networks For Solar-Array Modeling and Maximum Power-Point Prediction", IEE Proceeding-Generation, Transmission and Distribution, Vol. 147, No. 5, September 2000, pp. 310-316.
- [15] A. B. G. Bahgat, N. H. Helwa, G. E. Ahmad, and E. T. El Shenawy, "Maximum Power Point Tracking Controller for PV Systems Using Neural Networks", Renewable Energy Vol. 30, No. 8, July 2005, pp. 1257-1268.
- [16] H. Zhang and S. Cheng, "A New MPPT Algorithm Based on ANN in Solar PV Systems", Advances in Computer, Communication, Control & Automation, LNEE, Vol. 121, 2011, pp. 77-84.
- [17] M. A. Younis, T. Khatib, M. Najeeb, and A. M. Ariffin, "An Improved Maximum Power Point Tracking Controller for PV Systems Using Artificial Neural Network", Przegląd Elektrotechniczny, Vol. 88, No. 3b, 2012, pp. 116-121.
- [18] K. Ishaque and Z. Salam, "An Improved Modeling Method to Determine the Model Parameters of Photovoltaic (PV) Modules Using Differential Evolution (DE)", Solar Energy, Vol. 85, 2011, pp. 2349-2359.
- [19] K. Ishaque, Z. Salam, H. Taheri, and A. Shamsudin, "A Critical Evaluation of EA Computational Methods for Photovoltaic Cell Parameter Extraction Based on Two Diode Model", Solar Energy, Vol. 85, 2011, pp. 1768-1779.
- [20] R. Ramaprabha, V. Gothandaraman, K. Kanimozhi, R. Divya and B. L. Mathur, "Maximum Power Point Tracking using GA Optimized Artificial Neural Network for Solar PV System", IEEE Int. Conference on Electrical Energy Systems, 2011, pp. 264-268.
- [21] K. Ishaque, Z. Salam, M. Amjad, and S. Mekhilef, "An Improved Particle Swarm Optimization (PSO)-Based MPPT for PV with Reduced Steady-State Oscillation", IEEE Transactions on Power Electronics, Vol. 27, No. 8, August 2012, pp. 3627-3638.
- [22] Y. Zhao, X. Zhao, and Y. Zhang, "MPPT for Photovoltaic System Using Multi-Objective Improved Particle Swarm Optimization Algorithm", Teknika Indonesian Journal of Electrical Engineering, Vol. 12, No. 1, January 2014, pp. 261-268.
- [23] B. Pooja, S. S. Dub, J. B. Singh, and P. Lehana "Solar Power Optimization Using BFO Algorithm", Int. J. of Advanced Research in Computer Science and Software Engineering, Vol. 3, No. 12, December 2013, pp. 238-241.
- [24] A. S. Oshaba and E. S. Ali, "Bacteria Foraging: A New Technique for Speed Control of DC Series Motor Supplied by Photovoltaic System", International Journal of WSEAS Transactions on Power Systems, Vol. 9, 2014, pp. 185-195.
- [25] X. S. Yang, "BAT Algorithm for Multiobjective Optimization", Int. J. Bio-Inspired Computation", Vol. 3, No. 5, 2011, pp. 267-274.
- [26] T. C. Bora, L. S. Coelho, and L. Lebensztajn, "BAT-Inspired Optimization Approach for the Brushless DC Wheel Motor Problem", IEEE Transactions on Magnetics, Vol. 48, No. 2, 2012, pp. 947-950.
- [27] X. S. Yang and A. H. Gandomi, "BAT Algorithm: A Novel Approach for Global Engineering Optimization", Engineering Computations, Vol. 29, No. 5, 2012, pp. 464-483.
- [28] V. Rakesh, S. B. Aruna, and T. D. Raju, "Combined Economic Load And Emission Dispatch Evaluation Using BAT Algorithm", Int. J. of Engineering Research and Applications, Vol. 3, No.3, May-Jun 2013, pp.1224-1229.
- [29] B. Ramesh, V. C. J. Mohan, and V. C. V. Reddy, "Application of BAT Algorithm for Combined Economic Load And Emission Dispatch", Int. J. of Electrical and Electronic Engineering and Telecommunications, Vol. 2, No. 1, January 2013, pp.1-9.
- [30] Xin-She Yang, "BAT Algorithm: Literature Review and Applications", Int. J. Bio-Inspired Computation, Vol. 5, No.3, 2013, pp. 141-149.
- [31] S. Biswal, A. K. Barisal, A. Behera, and T. Prakash, "Optimal Power Dispatch Using BAT Algorithm", Int. Conference on Energy Efficient Technologies for Sustainability (ICEETS), Nagercoil 10-12 April 2013, pp.1018- 1023.
- [32] E. S. Ali, "Optimization of Power System Stabilizers using BAT search algorithm", Int. J. of Electrical Power and Energy Systems, Vol. 61, October 2014, pp. 683-690.
- [33] T. J. E. Miller, "Switched Reluctance Motors and their Control", Oxford Science Publications, London, 1993.
- [34] J. F. Gieras, "Advancements in Electric Machines", 2009, Springer.
- [35] R. D. Doncker, D. W. J. Pulle, and A. Veltman, "Advanced Electrical Drives: Analysis, Modeling, Control", ISBN 978-94-007-0181-6, Springer 2011.

- [36] A. S. Oshaba, "Performance of a Sensorless SRM Drive Fed from a Photovoltaic System", *Research Journal of Applied Sciences, Engineering and Technology*, Vol. 6, No. 17, 2013, pp. 3165-3173.
- [37] A. S. Oshaba, "Control Strategy for a High Speed SRM Fed from a Photovoltaic Source", *Research Journal of Applied Sciences, Engineering and Technology*, Vol. 6, No. 17, 2013, pp. 3174-3180.
- [38] D. Rekioua and E. Matagne, "Optimization of Photovoltaic Power Systems: Modelization, Simulation and Control", *Green Energy and Technology*, Springer 2012.
- [39] K. Hussein, I. Muta, T. Hoshino and M. Oskada, "Maximum Photovoltaic Power Tracking; An Algorithm for Rapidly Changing Atmospheric Conditions", *IEEE Proceedings Generation, Transmission and Distribution*, Vol. 142, No. 1, 1995, pp.59 -64.
- [40] C. F. Lu, C. C. Liu, and C. J. Wu, "Dynamic Modeling of Battery Energy Storage System and Application to Power System Stability", *IEE Proceedings Generation, Transmission & Distribution*, Vol. 142, No. 4, July 1995, pp.429-435.
- [41] B. K. Bose, "Modern Power Electronics and AC Drives", New Jersey: Prentice-Hall, 2002.
- [42] P. Z. Lin, C. F. Hsu, T. T. Lee, "Type -2 Fuzzy Logic Controller design for Buck DC-DC Converters", *Proceedings of the IEEE Int. Conf. on Fuzzy systems*, 2005, pp. 365- 370.
- [43] R. Mehta, and V. K. Mehta, "Principles of Electrical Machines", 2<sup>nd</sup> Edition, 2013, S. Chand.
- [44] N. Mohan, T. M. Undeland and W. P. Robbins, "Power Electronics Converters, Applications, and Design", 3<sup>rd</sup> Edition, 2003, John Wiley & Sons.
- [45] J. Kennedy and R. C. Eberhart, "Swarm Intelligence", the Morgan Kaufmann Series in Evolutionary Computation, 2001.
- [46] A. S. Oshaba, and E. S. Ali, "Speed Control of Induction Motor Fed from Wind Turbine via Particle Swarm Optimization Based PI Controller", *Research Journal of Applied Sciences, Engineering and Technology*, Vol. 5, No. 18, May 2013, pp. 4594-4606.
- [47] A. S. Oshaba, and E. S. Ali, "Swarming Speed Control for DC Permanent Magnet Motor Drive via Pulse Width Modulation Technique and DC/DC Converter", *Research Journal of Applied Sciences, Engineering and Technology*, Vol. 5, No. 18, May 2013, pp. 4576-4583.
- [48] T. V. Mahendiran, K. Thanushkodi, and P. Thangam, "Speed Control of Switched Reluctance Motor using New Hybrid Particle Swarm Optimization", *J. of Computer Science*, Vol. 8, No. 9, 2012, pp. 1473-1477.
- [49] S. M. Abd-Elazim, and E. S. Ali, "A Hybrid Particle Swarm Optimization and Bacterial Foraging for Optimal Power System Stabilizers Design", *Int. J. of Electrical Power and Energy Systems*, Vol. 46, No. 1, 2013, pp. 334-341.
- [50] E. S. Ali, and S. M. Abd-Elazim, "BFOA based Design of PID Controller for Two Area Load Frequency Control with Nonlinearities", *Int. J. of Electrical Power and Energy Systems*, Vol. 51, 2013, pp. 224-231.