

Implementation of a Impedance Source Inverter Based Variable Speed Wind Driven Self - Excited Induction Generator

M.Sasikumar and S.ChenthurPandian

Abstract - This paper deals with simulation and implementation of impedance source inverter fed self excited induction generator based wind energy conversion system. The variable speed wind driven self - excited induction generator and other power electronic converter components are modeled using MAT LAB / SIMULINK. Variable output voltage of the generator is rectified and it is inverted using a impedance source inverter. This inverter can produce an output voltage greater than the input voltage by controlling the shoot - through state duty cycle. The power conversion efficiency of the impedance source inverter is improved compared to the traditional voltage source inverter and current source inverters. Pulse width modulation scheme is used to control the impedance source inverter. The experimental results are compared with the simulation results.

Index Terms - Self-Excited Induction Generator, Wind Energy, Impedance Source Inverter, FFT Analysis.

I. INTRODUCTION

Wind is one of the major natural sources. It is non-polluting and economically viable source. Wind energy conversion scheme using a wind turbine driven SEIG, power electronic converter have been modeled, analyzed and implemented. The wind turbine generator system is producing a electricity from wind is the fastest growing energy technology in the world. Modern variable frequency drives operate by converting a 3 ϕ voltage source to DC using uncontrolled rectifier. The minimum and maximum values of capacitance required for self excitation have been analyzed previously [2][6]. Especially in remote areas, Self-Excited Induction Generators are producing good electricity compared to other generators. By using an advanced power electronic converter, the variable voltage variable frequency of the SEIG is

converted into constant voltage and constant frequency AC. The squirrel cage induction generators have robust construction, lower inertia, low run-time cost, less maintenance cost and better transient performance [5]. The reactive power requirement by the induction generator can also be supplied by a group of capacitors. If the capacitance is insufficient, the induction generators will not build up voltage [6]. The main drawback of the induction generator is need of reactive power to build up the terminal voltage. The analysis and performance of wind generator is given in [7]. Modeling and simulation of variable speed wind energy scheme is given by [8]. A steady state characteristic of three phase induction generator is given in [9]. The above literature does not deal with the power quality improvement of wind generator using AC to AC converter. The present work deals with simulation and implementation of wind generator with AC to AC converter system.

II. SYTEM CONFIGURATION

In this paper, a power generation system consisting of a wind turbine with a SEIG connected to the isolated load through a power electronic converter is considered. The variable output voltage from the generator is first rectified using diode bridge rectifier and then inverted by using Impedance source inverter. The output power of SEIG depends upon the wind velocity of the horizontal axis wind turbine. Excitation capacitors are used to reduce the reactive power burden of induction generators. The value of capacitance is to determine the output power production of SEIG. The variable magnitude and variable frequency output is given to the power electronic converters. The Z source inverter is used to get constant voltage, constant frequency. The pulse width modulation technique is used to control the inverter output voltage and frequency. The block diagram of the proposed system is shown in Fig 1.

M. Sasikumar is with the Department of Electrical and Electronics Engineering, Sathyabama University, Chennai, Tamilnadu, India. (e-mail: pmsasi77@yahoo.co.in).

S.Chenthur Pandian is with the Department of Electrical and Electronics Engineering, Selvam College of Technology, Namakkal, Tamilnadu, India. (e-mail: chenthur@rediffmailcom).

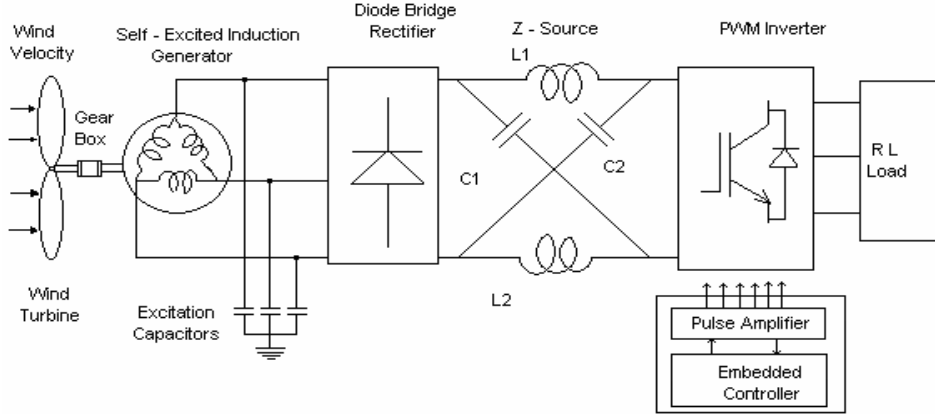

Fig. 1 Block Diagram of the Isolated Wind Energy Conversion System

a. Horizontal Axis Wind Turbine

The horizontal axis wind turbine acts as prime mover to drive induction generator. It has a simple principle, it produces electric power economically. The rotor blades are made up of reinforced glass fibre moulded on a steel shaft. The kinetic energy is converted into rotary mechanical energy by using the wind turbine rotor.

$$\text{Kinetic Energy} = \frac{0.5 \rho A V_w^3}{0.5 \rho A V^3}$$

The output power of wind turbine is given by $P_w = 0.5 \rho C_p A V_w^3$ (1)
 C_p is expressed as a function of λ

$$\lambda = \frac{R\omega}{V_w}$$

Dimensionless power co-efficient C_p

$$C_p = 0.5 \left[\frac{116}{\lambda_1} - 0.4\beta - 5 \right] e^{-\frac{16.5}{\lambda_1}} \quad (2)$$

The maximum theoretical power co efficient is equal to 0.593.

b. Self-Excited Induction Generator

The voltage is developed in the induction generator due to the residual magnetism. The terminal voltage will build up from small value to a rated value over a period of several seconds [9]. When the slip becomes negative, the output power and developed torque changes from positive to negative, which indicates the motor has become a generator. The dynamic characteristics of SEIG can be represented by the electromechanical equation derived in the synchronously rotating q-d reference frame [1][5].

$$p i_{qs} = -K_1 r_1 i_{qs} - (i_{qs}/Cv_{ds} + K_2 L_m w_m) i_{ds} + K_2 r_2 i_{qr} - K_1 L_m w_m i_{dr} \quad (3)$$

$$p i_{ds} = (i_{qs}/Cv_{ds} + K_2 L_m w_m) i_{qs} - K_1 r_1 i_{ds} + K_1 L_m w_m i_{qr} + K_2 r_2 i_{dr} - K_1 v_{ds} \quad (4)$$

$$p i_{qr} = -K_2 r_1 i_{qs} + L_1 K_2 w_m i_{ds} - (r_2 + K_2 L_m r_2) L_2 i_{qr} + (K_1 L_1 w_m - i_{qs}/Cv_{ds}) i_{dr} \quad (5)$$

$$p i_{dr} = -L_1 K_2 w_m i_{qs} + K_2 r_1 i_{ds} - (L_1 K_1 w_m - I_{qs}/Cv_{ds}) i_{qr} + (r_2 + K_2 L_m r_2) L_2 i_{dr} + K_2 v_{ds} \quad (6)$$

where

$$K_1 = \frac{L_r}{(L_s L_r - L_m^2)} \quad \text{and}$$

$$K_2 = \frac{L_m}{(L_s L_r - L_m^2)}$$

Equations (3.5)-(3.8) are derived assuming that the d-axis is aligned with the stator terminal voltage phasor (i.e., $V_{qs}=0$) [5]. In self-excited induction generators, the magnitude of the generated air-gap voltage in the steady state equation is given by

$$V_g = \omega_e L_m |i_m| \quad (7)$$

Where

$$|i_m| = \sqrt{(i_{qs} + i_{qr})^2 + (i_{ds} + i_{dr})^2} \quad (8)$$

The electromagnetic braking torque T_g developed by the induction generator is expressed as

$$T_g = -1.5 (\text{Poles}/2) L_m (i_{qs} i_{dr} - i_{ds} i_{qr}) \quad (9)$$

Wind turbine and induction generator rotors are represented as a lumped mass. So the dynamic equation of motion is written as

$$p\omega_r = (T_v/G_r - T_g)/J_g \quad (10)$$

c. Diode Bridge Rectifier and DC Link

Three phase diode bridge rectifier is used to convert variable magnitude, variable frequency voltage at the induction generator terminal into DC voltage [3].

The output voltage is expressed as

$$V_r = (3\sqrt{2}/\pi)(\sqrt{3}/\sqrt{2}) * V_{ds} * n_i \quad (11)$$

Input transformer's turns ratio is $1:\eta_i$. The series reactor (L) and shunt reactor (C) acts as an input filter. The current ripples and voltage ripples are reduced by using the above components [5]. Dc Link current is governed by the following equation

$$p i_{dc} = (1/L_{dc})(V_r - V_i - r_{dc} i_{dc}) \quad (12)$$

Where, R_{DC} and L_{DC} are the reactor resistance and inductance respectively.

d. Impedance Source Inverter

The output power of the rectifier is filtered by using the LC filter. The split inductors L_1, L_2 and capacitors C_1, C_2 are connected in X shape is provide high output voltage, higher efficiency and less distortion. All the pulse width modulation schemes can be used to control the Z – source inverter. In the case of the voltage source inverter used in WECS, the filtering element is to suppress only the voltage ripples. If the current source inverter is used in these WECS, the filtering element is to suppress current ripple. The Z source inverter circuit is consisting of two inductors and two capacitors. This Z – source network is more effective to suppress voltage and current ripples. This inverter makes the shoot – through zero state is possible. The peak dc link voltage across the inverter is expressed as

$$V_i = (T / T_1 - T_0) V_s \quad (13)$$

Where

T_0 - is the shoot through time period in secs

T_1 - is the non shoot through time period

T_2 - is the total time period in secs

Compared to the traditional inverters, the harmonic distortion is low. In this inverter can be used as buck mode and boost modes.

III. SIMULATION RESULTS

The Z – source inverter based wind driven SEIG system is simulated using MATLAB / SIMULINK and the results are presented. The simulink model of the SEIG fed ZSI inverter with RL load is shown in Fig 3. Three axes to two axes transformation is used for the calculation of dynamic frequency value. The generator output voltage is shown in Fig. 3.1. The value of minimum and maximum capacitance required for self – excitation have been previously analyzed in [6]. The Line voltage, Line current and Phase voltage are shown in Figs. 3.2, 3.3 and 3.4 respectively. Frequency spectrum is shown in Fig 3.5. THD value is 4.94%. Harmonic distortion is reduced due to the presence of filter at the output. Thus the THD is minimum with ZSI fed inverter system.

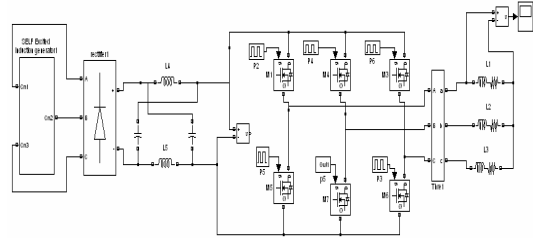

Fig.3. SEIG with ZSI Fed Inverter

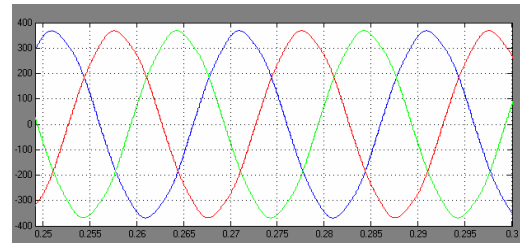

Fig 3.1 Generator Voltage

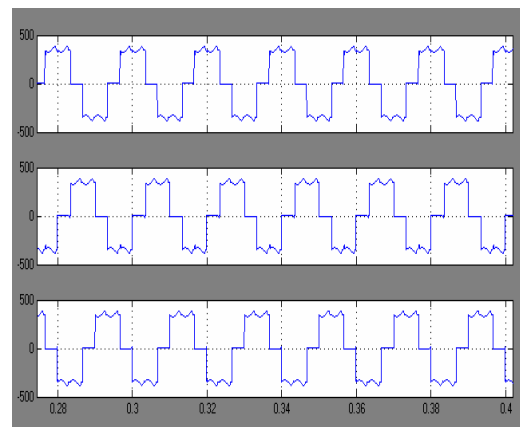

Fig 3.2 Line Voltage

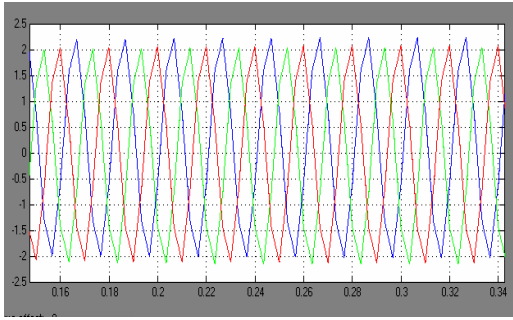

Fig 3.3 Line Current

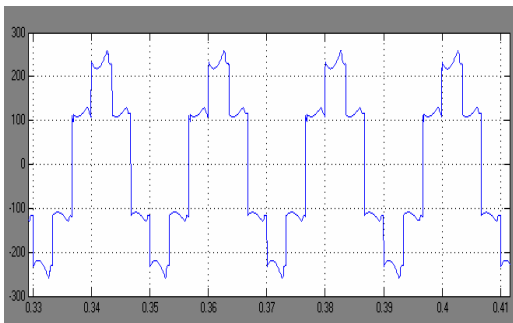

Fig 3.4 Phase Voltage

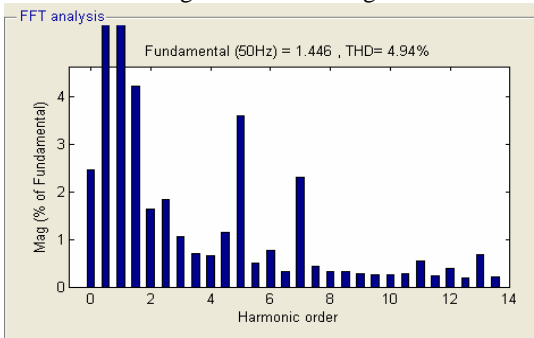

Fig 3.5 FFT Analysis for Current

IV EXPERIMENTAL RESULTS

A low cost embedded controller based ZSI fed RL load is shown in Fig 4.1. The output terminal of SEIG is connected to the excitation capacitors. The induction generator needs reactive power to build up the terminal voltage. The diode bridge rectifier is used to convert the variable magnitude, variable frequency voltage at the induction generator terminal to DC. The z source network makes the shoot – through zero state possible. This shoot through zero state provides the unique buck – boost features to the inverter. Driving pulses for the switches T₂, T₄ are shown in Figs. 4.2. The available shoot – through period is limited by the zero – state period. That is

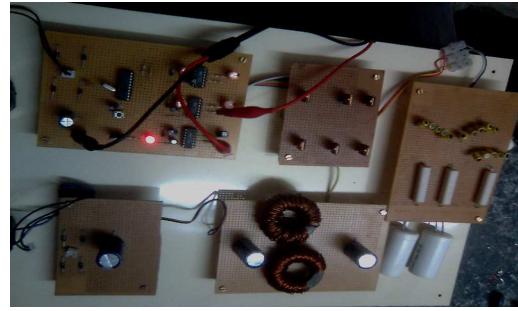

Fig 4.1 Experimental Setup of Embedded Controller based ZSI for WECS

determined by the modulation index. The output line voltage of the ZSI fed R load and RL load is shown in Fig 4.3 & 4.4 respectively. The output voltage of the ZSI entirely depends on the shoot through states.

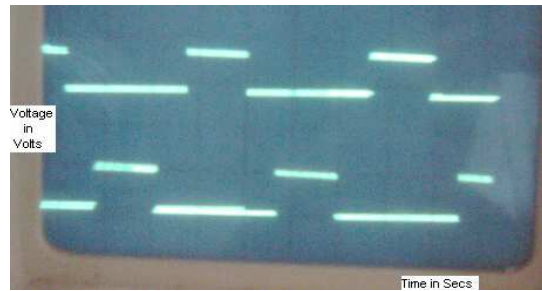

Fig 4.2 Driving Pulses for T₂ and T₄

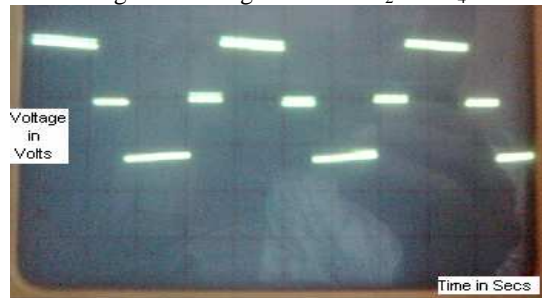

Fig 4.3 Output Line Voltage with R Load

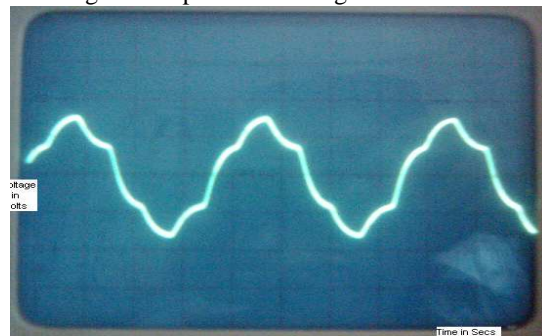

Fig 4.4 Output Line Voltage with RL Load

V CONCLUSION

The performance of Z – source inverter for SEIG fed wind energy conversion system has been proposed and corresponding simulated waveforms are verified. The output voltage of the Z – source inverter is entirely depends upon the shoot through states. The hardware is implemented using ZSI system since it has reduced THD. The hardware is tested and the results are presented. The experimental results coincide with the simulation results.

REFERENCES

1. Dawit S Eyaum Colin Grantham, and Muhammed Fazlur Rahman, "The dynamic characteristics of an isolated self-excited induction generator driven by a wind turbine", IEEE, Transaction on Industry applications, Vol. 39.No.4 , July/August 2003 pp 936 - 944.
2. Tarek Ahmed, Osamu Noro, Kazuya Matsuo, Yuji Shindo, and Mutsuo Nakaoka, "Minimum Excitation Capacitance Requirements For Wind Turbine Coupled Stand-alone Self-Excited Induction Generator With Voltage Regulation Based On SVC", Proceedings of IEEE, INTELEC, 2003, pp 396 – 403.
3. Yaser Anagreh "Steady state performance of series DC motor powered by wind driven self-excited induction generator," Rev. Energ. Ren: power Engineering, 2001,pp 9-15.
4. Andrew Miller, Edward Muljadi and Donald S. Zinger, "A Variable Speed Wind Turbine Power Control", IEEE, Transaction on Energy Conversion, Vol. 12.No.2 June 1997, pp – 181- 186.
5. Rohin M. Hilloowala and Adel M. Sharaf, "A Rule-Based Fuzzy Logic Controller for a PWM Inverter in a Stand alone Wind Energy Conversion Scheme" IEEE, Transaction on Industry Applications, Vol. 32.No.1 January/February 1996, pp 57- 65.
6. T.F. Chan." Capacitance requirements of self-excited induction generators ", IEEE Transactions on Energy Conversion, Vol. 8, No. 2, June 1993 pp 304-311.
7. Li Wang, Chaing-Huei Lee , "A novel analysis and the performance of an Isolated self excited induction generators," IEEE Trans. on Energy conversion June 1993, vol.12, No.2.
8. Rohin M.Hilluwala and Sharaf.A.M "Modeling, Simulation and Analysis of variable speed constant frequency wind energy conversion scheme using self excited induction generator," IEEE Trans. on Energy conversion, 1991.
9. Al-Bahrani.A.H and Malik.N.H., "Steady state analysis and performance characteristics of a three phase induction generator self excited with a single capacitor," IEEE Trans. on Energy conversion, December 1990, vol.5, No.4



Sasikumar.M has received the B.E degree in Electrical and Electronics Engineering from K.S.Rangasamy College of Technology, Madras University, India in 1999, and the M.Tech degree in power electronics from VIT University, in 2006. Currently, he is Research Scholar in Sathyabama University, Chennai. His research interest is on wind energy systems.



Dr.S.Chenthur Pandian was born in Tamilnadu, India in 1959. He was graduated from the institution of engineers, calcuta (India) and received his post graduate degree from Punjab University, Chandigarh (India). He has obtained his Ph.d. degree from periyar university, salem, Tamilnadu, India. Currently he is working as a Principal in Selvam College of Technology, Namakkal, and Tamilnadu, India. His research areas are power system, power electronics, neural network, fuzzy logic and Neuro – fuzzy systems. He is a member of ISTE, IE & IEEE.